

---

---

**ADVANTEST®**

**ADVANTEST CORPORATION**

---

***R3681 Series OPT72***

***Digital Signal Generator Module***

***User's Guide***

**MANUAL NUMBER FOE-8440152D00**

---

***Applicable Models***

***R3681***

***R3671***



## TABLE OF CONTENTS

1.	INTRODUCTION .....	1-1
1.1	Organization of This Document .....	1-1
1.2	Product Overview .....	1-2
1.3	Other Manuals Pertaining to This Instrument .....	1-2
1.4	Conventions of Notation Used in This Document .....	1-3
1.5	Trademarks and Registered Trademarks .....	1-4
2.	PRE-OPERATION TIPS .....	2-1
2.1	If Faults Should Occur .....	2-1
2.2	Removing of Case .....	2-1
2.3	Overcurrent Protection .....	2-1
2.4	Hard Disk Drive .....	2-1
2.5	Handling the Touch Screen .....	2-2
2.6	Getting the Software Running with Stability .....	2-2
2.7	Tip on Transportation .....	2-3
2.8	Electromagnetic Interference .....	2-3
2.9	About Replacement of Limited-Life Parts .....	2-3
2.10	Limitations Imposed when Using Windows XP .....	2-4
3.	SETUP .....	3-1
3.1	Unpacking Inspection .....	3-1
3.2	Locating This Instrument .....	3-2
3.2.1	Operating Environment .....	3-2
3.2.2	Prevention of Electrostatic Buildup .....	3-3
3.3	Connecting Accessories .....	3-5
3.3.1	Connecting the Keyboard and Mouse .....	3-5
3.4	Supply Description .....	3-6
3.4.1	Check the supply power .....	3-6
3.4.2	Connecting the Power Cable .....	3-6
3.5	Operation Check .....	3-8
4.	EXAMPLES OF OPERATIONS .....	4-1
4.1	Description of the Panels and the Screen .....	4-1
4.1.1	The Name and Functions of Each Component on the Front Panel .....	4-1
4.1.2	Name and Function of Each Part of the Screen .....	4-5
4.1.3	The Name and Functions of Each Component on the Rear Panel .....	4-6
4.2	Basic Operation .....	4-7
4.3	Operating Method .....	4-7
4.3.1	Operation from Waveform File Loading to I/Q Signal Output .....	4-7
4.3.2	Operation of BER Measurement .....	4-17
4.3.3	Operation of RF Signal Output .....	4-23

Table of Contents

5.	MENU MAP, FUNCTIONAL EXPLANATION .....	5-1
5.1	Menu Index .....	5-1
5.2	Switching SG+AWG .....	5-3
5.3	Function Bar .....	5-3
5.4	Soft Menu Bar .....	5-3
5.5	Description of the Function of Each Key .....	5-4
5.5.1	{BER} .....	5-4
5.5.2	{AWG} .....	5-9
5.5.3	{MOD} .....	5-20
5.5.4	{AMPL} .....	5-22
5.5.5	{FREQ} .....	5-25
5.6	Tool Menu .....	5-27
6.	SCPI COMMAND REFERENCE .....	6-1
6.1	Command Reference Format .....	6-1
6.2	Common Commands .....	6-3
6.3	BER Button .....	6-4
6.4	AWG Button .....	6-6
6.5	AWG Button .....	6-8
6.6	AMPL Button .....	6-9
6.7	FREQ Button .....	6-10
6.8	Menu Bar Related Functions .....	6-11
6.9	Tool Menu Related Functions .....	6-12
6.10	Functions Dedicated to Remote Control .....	6-12
6.11	Status Register .....	6-13
6.12	Example of Remote Control Program .....	6-15
6.12.1	BER Measurement .....	6-15
7.	SPECIFICATIONS .....	7-1
7.1	AWG Specifications .....	7-1
7.2	SG Specifications .....	7-3
8.	PERFORMANCE VERIFICATION .....	8-1
8.1	Overview .....	8-1
8.1.1	Introduction .....	8-1
8.1.2	Required Instruments .....	8-3
8.2	Loading Waveform Data .....	8-5
8.3	AWG Performance Verification Procedure .....	8-7
8.3.1	Signal Output .....	8-7
8.3.2	Output Amplitude .....	8-10
8.3.3	Residual DC Offset .....	8-13
8.3.4	DC Offset .....	8-16
8.3.5	Sampling Frequency .....	8-18
8.3.6	Phase Difference between Channels .....	8-21

8.3.7	SFDR .....	8-23
8.3.8	Internal Filter .....	8-26
8.3.9	External Start Trigger .....	8-29
8.3.10	Marker 1 Output .....	8-37
8.3.11	Marker 2 Output .....	8-40
8.3.12	Bit Error Rate Counter .....	8-44
8.4	AWG Performance Verification Record Sheets .....	8-47
8.4.1	Signal Output .....	8-47
8.4.2	Output Amplitude .....	8-47
8.4.3	Residual DC Offset .....	8-48
8.4.4	DC Offset .....	8-48
8.4.5	Sampling Frequency .....	8-49
8.4.6	Phase Difference between Channels .....	8-49
8.4.7	SFDR .....	8-49
8.4.8	Internal Filter .....	8-49
8.4.9	External Start Trigger .....	8-50
8.4.10	Marker 1 Output .....	8-50
8.4.11	Marker 2 Output .....	8-50
8.4.12	Bit Error Rate Counter .....	8-51
8.5	SG Performance Verification Procedure .....	8-52
8.5.1	Frequency Accuracy .....	8-52
8.5.2	Level Accuracy .....	8-55
8.5.3	Attenuator Hold Level Variable Range .....	8-58
8.5.4	ALC Hold ADJ Accuracy .....	8-60
8.5.5	SSB Phase Noise .....	8-62
8.5.6	Broadband Noise .....	8-65
8.5.7	Harmonics .....	8-68
8.5.8	Non-harmonics .....	8-71
8.5.9	Modulation Accuracy .....	8-74
8.5.10	Origin Offset .....	8-77
8.5.11	ACLR .....	8-80
8.5.12	External IQ Input .....	8-83
8.6	SG Performance Verification Record Sheets .....	8-87
8.6.1	Frequency Accuracy .....	8-87
8.6.2	Level Accuracy .....	8-87
8.6.3	Attenuator Hold Level Variable Range .....	8-88
8.6.4	ALC Hold ADJ Accuracy .....	8-88
8.6.5	SSB Phase Noise .....	8-88
8.6.6	Broadband Noise .....	8-89
8.6.7	Harmonics .....	8-89
8.6.8	Non-harmonics .....	8-90
8.6.9	Modulation Accuracy .....	8-90
8.6.10	Origin Offset .....	8-91
8.6.11	ACLR .....	8-91
8.6.12	External IQ Input .....	8-91
APPENDIX .....		A-1
A.1	Method to Create a Waveform File .....	A-1
A.1.1	Waveform File Configuration .....	A-1

---

Table of Contents

A.1.2	Header .....	A-2
A.1.3	Header Syntax .....	A-3
A.1.4	Waveform Data Generation (Waveform Data Part) .....	A-7
A.2	Principle of Operation .....	A-12
A.3	Error Codes .....	A-16
A.4	Description of Standard Waveform Generation Software .....	A-20
A.4.1	Overview .....	A-20
A.4.2	Software Activation .....	A-22
A.4.3	Window and Menus .....	A-23
A.4.4	Function of Each Block .....	A-27
A.4.5	Format of Files to Be Loaded in Each Block .....	A-39
A.4.6	Error Codes for Standard Waveform Generation Software .....	A-44
ALPHABETICAL INDEX .....		I-1

## LIST OF ILLUSTRATIONS

No.	Title	Page
3-1	Operating Environment .....	3-2
3-2	Countermeasures for Static Electricity of Human Body .....	3-3
3-3	Countermeasures for Static Electricity on Work Floor .....	3-3
3-4	Countermeasures for Static Electricity on Workbench .....	3-4
3-5	Connecting the Keyboard and Mouse .....	3-5
3-6	Connecting the Power Cable .....	3-7
3-7	<b>POWER</b> Switch .....	3-8
3-8	Initial Setting Screen .....	3-9
3-9	SG+AWG Initial Setting Screen .....	3-10
4-1	Front Panel .....	4-1
4-2	Entry Key Block .....	4-2
4-3	I/F Connector Block .....	4-3
4-4	I/O Connector Block .....	4-3
4-5	Screen Display .....	4-5
4-6	Rear Panel .....	4-6
4-7	Initial Setting Screen .....	4-9
4-8	Connection Diagram .....	4-10
4-9	SG+AWG Screen .....	4-11
4-10	<b>[Waveform Setup]</b> Dialog Box .....	4-11
4-11	<b>[Memory Segments]</b> Change Inquiry Message Box .....	4-12
4-12	<b>[Select Waveform]</b> Dialog Box .....	4-12
4-13	<b>[Waveform Setup]</b> Dialog Box .....	4-12
4-14	<b>[Output Setup]</b> Dialog Box .....	4-13
4-15	<b>[Marker Setup]</b> Dialog Box .....	4-14
4-16	<b>[I/Q Output Control]</b> Dialog Box .....	4-16
4-17	Initial Setting Screen .....	4-18
4-18	Connection Diagram .....	4-19
4-19	SG+AWG Screen .....	4-20
4-20	Bit Error Rate Measurement Screen .....	4-20
4-21	<b>[Bit Error Rate Counter Setup]</b> Dialog Box .....	4-21
4-22	Bit Error Rate Measurement Result Screen .....	4-22
4-23	Initial Setting Screen .....	4-25
4-24	Connection diagram .....	4-26
4-25	Example of Checking the SG OUTPUT Signal by Using the SA .....	4-28
6-1	Status Register Details .....	6-14
8-1	Signal Output Accuracy Test Connection Diagram .....	8-7
8-2	Output Amplitude Verification Connection Diagram .....	8-10
8-3	Residual DC Offset Measurement Connection Diagram .....	8-13
8-4	DC Offset Verification Connection Diagram .....	8-16
8-5	Sampling Frequency Verification Connection Diagram .....	8-18
8-6	Phase Difference between Channels Measurement Connection Diagram .....	8-21
8-7	SFDR Measurement Connection Diagram .....	8-23
8-8	Internal Filter Verification Connection Diagram .....	8-26

List of Illustrations

No.	Title	Page
8-9	External Start Trigger Verification Connection Diagram .....	8-29
8-10	Waveform for Continuous, Positive .....	8-34
8-11	Waveform for Continuous, Negative .....	8-34
8-12	Waveform for Single, Once, Positive .....	8-34
8-13	Waveform for Single, Once, Negative .....	8-34
8-14	Waveform for Single, Three Times, Positive .....	8-35
8-15	Waveform for Single, Three Times, Negative .....	8-35
8-16	Waveform for Gated (edge), Positive .....	8-35
8-17	Waveform for Gated (edge), Negative .....	8-35
8-18	Waveform for Gated (level), Positive .....	8-36
8-19	Waveform for Gated (level), Negative .....	8-36
8-20	Marker 1 Output Verification Connection Diagram .....	8-37
8-21	Marker 2 Output Verification Connection Diagram .....	8-40
8-22	Reference Waveform for Sequence Marker, Positive .....	8-43
8-23	Reference Waveform for Sequence Marker, Negative .....	8-43
8-24	Reference Waveform for Memory Marker .....	8-43
8-25	Bit Error Rate Counter Verification Connection Diagram .....	8-44
8-26	Connection Diagram for the Frequency Accuracy Verification .....	8-52
8-27	Level Accuracy Verification Connection Diagram .....	8-55
8-28	Verification Connection Diagram of the Attenuator Hold Level Variable Range .....	8-58
8-29	Verification Connection Diagram of the ALC Hold ADJ Accuracy .....	8-60
8-30	SSB Phase Noise Verification Connection Diagram .....	8-62
8-31	Broadband Noise Verification Connection Diagram .....	8-65
8-32	Harmonics Verification Connection Diagram .....	8-68
8-33	Non-harmonics Verification Connection Diagram .....	8-71
8-34	Modulation Accuracy Verification Connection Diagram .....	8-74
8-35	Origin Offset Verification Connection Diagram .....	8-77
8-36	ACLR Verification Connection Diagram .....	8-80
8-37	External IQ Input Verification Connection Diagram .....	8-84
A-1	Waveform Data Generation Procedures .....	A-7
A-2	I Waveform Frame .....	A-7
A-3	Q Waveform Frame .....	A-8
A-4	Conversion .....	A-8
A-5	Relationships between DAC Data and I/Q Output Voltages (for Fix Gain Path) .....	A-9
A-6	Relationships between DAC Data and I/Q Output Voltages (for Variable Gain Path) ...	A-10
A-7	Block Diagram .....	A-12
A-8	Memory Block Diagram .....	A-13
A-9	Analog Board Block Diagram .....	A-14
A-10	Signal Generation Block Diagram .....	A-20
A-11	After the Standard Waveform Generation Software is Activated .....	A-22
A-12	Main Window .....	A-23
A-13	File Menu .....	A-24
A-14	Diagram Menu .....	A-24
A-15	Setup Menu .....	A-25
A-16	Help Menu .....	A-26
A-17	Dialog Box to Make Settings for the Data Generation Block .....	A-27
A-18	Dialog Box to Make Settings for the Modulation Block .....	A-29



No.	Title	Page
A-19	Dialog Box to Make Settings for "Import Symbol Data Function" .....	A-31
A-20	Dialog Box to Make Settings for Filter Block .....	A-32
A-21	Dirac Pulse .....	A-33
A-22	Rectangular .....	A-33
A-23	Dialog Box to Make Settings for Signal Addition Block .....	A-35
A-24	Dialog Box for Signal Addition Block .....	A-36
A-25	Dialog Box to Make Settings for the IF Carrier Block .....	A-37



## LIST OF TABLES

No.	Title	Page
2-1	Limited-Life Parts .....	2-3
3-1	Standard Accessories (OPT72) .....	3-1
3-2	ESD Countermeasures .....	3-3
3-3	Power Supply Specifications .....	3-6
8-1	Performance Verification List (AWG) .....	8-1
8-2	Performance Verification List (SG) .....	8-2
8-3	Required Instruments List (AWG) .....	8-3
8-4	Required Instruments List (SG) .....	8-4
8-5	Signal Output Verification Setting List .....	8-9
8-6	Setting Center Frequency for Sampling Frequency and Frequency Reference Value .....	8-20
8-7	Internal Filter Verification Setting List .....	8-28
A-1	File Menu .....	A-24
A-2	Diagram Menu .....	A-24
A-3	Setup Menu .....	A-25
A-4	Help Menu .....	A-26
A-5	Selectable Generated Codes .....	A-27
A-6	Parameters for which Settings can be Made .....	A-29
A-7	Relationships between Sequence Length and the Number of Generated Codes on a Modulation Type Basis .....	A-30
A-8	Parameters for which Settings can be Made .....	A-31
A-9	Parameters for which Settings can be Made .....	A-32
A-10	Parameters for which Settings can be Made .....	A-35
A-11	Parameters for which Settings can be Made .....	A-36
A-12	Parameters for which Settings can be Made .....	A-37



## 1. INTRODUCTION

This chapter introduces you to the organization of this document and a product overview of the R3681 Series Signal Analyzer (Option 72) to help you get the most out of this document.

### 1.1 Organization of This Document

The contents of each chapter of this manual are as follows:

For more information on the basic operating method, functions, and remote programming of the signal analyzer, refer to 1.3, "Other Manuals Pertaining to This Instrument."

Chapter 1, "INTRODUCTION"	Introduces you to the organization of this document and a product overview to help you get the most out of this document.
Chapter 2, "PRE-OPERATION TIPS"	Provides preliminary tips on using this instrument. Read this chapter before using this instrument.
Chapter 3, "SETUP"	Explains how to set up this instrument on delivery. After installing this instrument in position, switch it on to make sure that it starts up successfully.
Chapter 4, "EXAMPLES OF OPERATIONS"	Describes the functions of each part of the panel and screen of this instrument. You can learn the basic operating method of this instrument by basic operation.
Chapter 5, "MENU MAP, FUNCTIONAL EXPLANATION"	Explains the menu configuration and function of the soft keys.
Chapter 6, "SCPI COMMAND REFERENCE"	SCPI command reference. The command reference explains the commands in order of function.
Chapter 7, "SPECIFICATIONS"	Describes the specifications of option 72.
Chapter 8, "PERFORMANCE VERIFICATION"	Describes the performance test items and performance test procedures of option 72. Provides a performance test record sheet.
APPENDIX	Provides the following information: <ul style="list-style-type: none"> <li>• Method to Create a Waveform File</li> <li>• Principle of Operation</li> <li>• Error Codes</li> <li>• Description of Standard Waveform Generation Software</li> </ul>

## 1.2 Product Overview

This option (OPT72) generates the signal which corresponds to the digital modulation. This option includes the high purity synthesizer, the broadband quadrature modulator, and the arbitrary waveform generation (AWG) function which generates the flexible modulation signal. And also the BER counter, which is essential for measuring the quality of data communication, is included.

The main features of this instrument are shown below:

- RF output frequency range: 50 MHz to 6 GHz (R3681)  
50 MHz to 3 GHz (R3671)
- Sampling rate that allows wideband modulation: 12.5 MHz to 200 MHz
- Large-capacity waveform data memory: 128 M samples (I and Q in total)
- Built-in bit error rate counter
- Integration of the analyzer (this instrument) and generator (this option) function

## 1.3 Other Manuals Pertaining to This Instrument

Available manuals pertaining to the R3681 Series include:

- User's Guide (Part Code: {ER3681SERIES/U}, English)  
Contains information prerequisite to using the R3681 Series Signal Analyzer, ranging from setup to basic operation, applied measurement, functionality, specifications, and maintenance.
- Programming Guide (Part Code: {ER3681SERIES/P}, English)  
Covers programming information to use the R3681 Series Signal Analyzer to automate measurement sequences, including a remote control overview, SCPI command references, and sample application programs.
- Performance Test Guide (Part Code: {ER3681SERIES/T}, English)  
Covers information necessary to verify the performance of the R3681 Series Signal Analyzer, including performance test procedures and specifications.

## 1.4 Conventions of Notation Used in This Document

In this document, panel keys, on-screen buttons and menus are represented by the following symbols:

On-panel hard keys

**Sample**

Represents an on-panel hard key labeled "Sample."

Example: **START**, **STOP**

On-screen system menus

**[Sample]**

Represents an on-screen menu, tab, button or dialog box that is labeled "Sample" and that is selected or executed when touched.

Example: **[File]** menu, **[Normal]** tab, **[Option]** button

On-screen function buttons

**{Sample}**

Represents an on-screen function button labeled "Sample."

Example: **{FREQ}** button, **{SWEEP}** button

On-screen side menu

**Sample**

Represents an on-screen side menu key labeled "Sample."

Example: **Center** key, **Span** key

On-screen system menu key operation

**[File]→[Save As...]**

Indicates a touch on the **[File]** menu followed by a choice of **[Save As...]**.

Sequential key operation

**{FREQ}, Center**

Indicates a touch on the **{FREQ}** button followed by a touch on the **Center** key.

Toggle key operation

**ΔMarker On/Off** (On)

Indicates a touch on the **ΔMarker On/Off** key to turn on the ΔMarker.

---

**NOTE:** Screen displays and diagrams such as external view of the main unit in this manual are those of the R3681 in the R3681 series.

---

## 1.5 Trademarks and Registered Trademarks

### **1.5 Trademarks and Registered Trademarks**

- Microsoft® and Windows® are trademarks or registered trademarks of Microsoft Corporation in the United States and other countries.
- Other product and company names referenced herein are trademarks or registered trademarks of their respective owners.



## 2. PRE-OPERATION TIPS

This chapter provides preliminary tips on using this instrument. Read this chapter before using this instrument.

### 2.1 If Faults Should Occur

If this instrument is found to smoke or deliver offensive odors or abnormal noises, switch off the power breaker and remove the power cable from the AC power connector to power off this instrument. Then, contact your dealer or us immediately.

### 2.2 Removing of Case

The case should not be opened except by service personnel of our company.

---

**WARNING:** *High-voltage and high-temperature parts inside. You may get electrical shocks or burnt if you touch them.*

---

### 2.3 Overcurrent Protection

This instrument is protected from overcurrent flow by a power breaker.

Located on the rear panel, the power breaker automatically forces an interruption of the power supply when an overcurrent flows through this instrument. When the power breaker has turned off, remove the power cable from the AC power connector to power off this instrument. Then, call upon your dealer or us for repair services to fix a possible fault that has occurred in this instrument.

### 2.4 Hard Disk Drive

This instrument has a built-in hard disk drive. When handling the hard disk drive, take notice of these instructions.

- Do not impact or vibrate the hard disk drive.  
Damage to the disk on which data is stored could result, increasing the chances of malfunctioning or failing during operations.
- Do not switch off this instrument while the HDD access lamp is lit.  
The data being accessed might be damaged.

---

**CAUTION:** *We do not assume any responsibility for the loss or corruption of data stored on the hard disk drive that might result from its faults.*

---

## 2.5 Handling the Touch Screen

### 2.5 Handling the Touch Screen

This instrument has a touch screen. When handling the touch screen, take notice of these instructions.

- Do not give strong impacts or apply undue force to the screen.  
The glass could be cracked.
- Use the stylus pen included with this instrument to operate the screen.  
Use of a hard-pointed material (such as a mechanical pencil or ballpoint) could scratch the screen surface.

### 2.6 Getting the Software Running with Stability

The R3681 Series Signal Analyzer has Microsoft Windows XP pre-installed.

The measuring function of this instrument is dependent on the Windows environment. Do not alter the Windows operating environment in any way other than as described in this manual.

Furthermore, this instrument is not a data processor. Operate it only as described in this manual.

1. Non-permitted actions:

- Installing other application programs.
- Changing or deleting items in the control panel (except for A.2, "Installing the Printer Driver" and A.3, "Setting up the Network" of the R3681 Series User's Guide).
- Opening or operating the existing files on the C drive.
- Operating other application programs during the measurement.
- Upgrading the Windows operating system.
- If this instrument does not function correctly due to any of the above, re-install the system using the system recovery disk.  
For the method for recovery, refer to the R3681 Series User's Guide.

2. Computer viruses

Depending on the operating environment and method, the system can be contaminated by a computer virus.

To use the system securely, it is recommended to take the following countermeasures:

- Run a virus check before loading a file or media from an outside source.
- Make sure that any network has safety measures against computer viruses before connecting.

[If infected with a computer virus:]

- Delete all files on the D drive. Re-install the system using the recovery disk.  
For more information on the system recovery method, refer to the R3681 Series User's Guide.

## 2.7 Tip on Transportation

This instrument is heavy, so two or more people should carry it or a dolly should be used to transport it.

## 2.8 Electromagnetic Interference

This instrument may cause electromagnetic interference and affect television and radio reception. If this instrument's power is turned off and the electromagnetic interference is reduced, then this instrument has caused the problem.

Electromagnetic interference may be prevented by doing the following:

- Change the direction of the antenna of the television or radio.
- Place this instrument on the other side of the television or radio.
- Place this instrument away from the television or radio.
- Use different lines for the power sources for the television or radio and this instrument.

## 2.9 About Replacement of Limited-Life Parts

Table 2-1 lists the proper limited-life parts of this instrument.

The table also shows the number of operations for the expected life spans of each of these parts, to suggest a recommended time of replacement in terms of the number of times of operations. For replacement, call the Service Center (Advantest Customer Support (ACS)).

Note that the life span can become shorter than expected depending on the operation environment, frequency of use, and storage environment.

---

**MEMO:** *The table shows the expected life spans or recommended time of replacement only for the user's reference. It does not guarantee the life of the components.*

---

Table 2-1 Limited-Life Parts

Name	Life (Reference values provided by manufacturer)
Mechanical relay, RF block	$25 \times 10^5$ operations

2.10 Limitations Imposed when Using Windows XP

2.10 Limitations Imposed when Using Windows XP

**END-USER LICENSE AGREEMENT**

- You have acquired a device ("INSTRUMENT") that includes software licensed by [ADVANTEST] from Microsoft Licensing Inc. or its affiliates ("MS"). Those installed software products of MS origin, as well as associated media, printed materials, and "online" or electronic documentation ("SOFTWARE") are protected by international intellectual property laws and treaties. The SOFTWARE is licensed, not sold. All rights reserved.
- IF YOU DO NOT AGREE TO THIS END USER LICENSE AGREEMENT ("EULA"), DO NOT USE THE INSTRUMENT OR COPY THE SOFTWARE. INSTEAD, PROMPTLY CONTACT [ADVANTEST] FOR INSTRUCTIONS ON RETURN OF THE UNUSED INSTRUMENT(S) FOR A REFUND. ANY USE OF THE SOFTWARE, INCLUDING BUT NOT LIMITED TO USE ON THE INSTRUMENT, WILL CONSTITUTE YOUR AGREEMENT TO THIS EULA (OR RATIFICATION OF ANY PREVIOUS CONSENT).
- **GRANT OF SOFTWARE LICENSE.** This EULA grants you the following license:
  - You may use the SOFTWARE only on the INSTRUMENT.
  - **NOT FAULT TOLERANT.** THE SOFTWARE IS NOT FAULT TOLERANT. [ADVANTEST] HAS INDEPENDENTLY DETERMINED HOW TO USE THE SOFTWARE IN THE INSTRUMENT, AND MS HAS RELIED UPON [ADVANTEST] TO CONDUCT SUFFICIENT TESTING TO DETERMINE THAT THE SOFTWARE IS SUITABLE FOR SUCH USE.
  - **NO WARRANTIES FOR THE SOFTWARE.** THE SOFTWARE is provided "AS IS" and with all faults. THE ENTIRE RISK AS TO SATISFACTORY QUALITY, PERFORMANCE, ACCURACY, AND EFFORT (INCLUDING LACK OF NEGLIGENCE) IS WITH YOU. ALSO, THERE IS NO WARRANTY AGAINST INTERFERENCE WITH YOUR ENJOYMENT OF THE SOFTWARE OR AGAINST INFRINGEMENT. IF YOU HAVE RECEIVED ANY WARRANTIES REGARDING THE INSTRUMENT OR THE SOFTWARE, THOSE WARRANTIES DO NOT ORIGINATE FROM, AND ARE NOT BINDING ON, MS.
  - **No Liability for Certain Damages.** EXCEPT AS PROHIBITED BY LAW, MS SHALL HAVE NO LIABILITY FOR ANY INDIRECT, SPECIAL, CONSEQUENTIAL OR INCIDENTAL DAMAGES ARISING FROM OR IN CONNECTION WITH THE USE OR PERFORMANCE OF THE SOFTWARE. THIS LIMITATION SHALL APPLY EVEN IF ANY REMEDY FAILS OF ITS ESSENTIAL PURPOSE. IN NO EVENT SHALL MS BE LIABLE FOR ANY AMOUNT IN EXCESS OF U.S. TWO HUNDRED FIFTY DOLLARS (U.S.\$250.00).
  - **Limitations on Reverse Engineering, Decompilation, and Disassembly.** You may not reverse engineer, decompile, or disassemble the SOFTWARE, except and only to the extent that such activity is expressly permitted by applicable law notwithstanding this limitation.
  - **SOFTWARE TRANSFER ALLOWED BUT WITH RESTRICTIONS.** You may permanently transfer rights under this EULA only as part of a permanent sale or transfer of the INSTRUMENT, and only if the recipient agrees to this EULA. If the SOFTWARE is an upgrade, any transfer must also include all prior versions of the SOFTWARE.
  - **EXPORT RESTRICTIONS.** You acknowledge that SOFTWARE is of US-origin. You agree to comply with all applicable international and national laws that apply to the SOFTWARE, including the U.S. Export Administration Regulations, as well as end-user, end-use and country destination restrictions issued by U.S. and other governments. For additional information on exporting the SOFTWARE, see <http://www.microsoft.com/exporting/>.
- **Installation and Use.** The SOFTWARE may not be used by more than two (2) processors at any one time on the INSTRUMENT. You may permit a maximum of ten (10) computers or other electronic devices (each a "Client") to connect to the INSTRUMENT to utilize the services of the SOFTWARE solely for file and print services, internet information services, and remote access (including connection sharing and telephony services). The ten (10) connection maximum includes any indirect connections made through "multiplexing" or other software or hardware which pools or aggregates connections. Except as otherwise permitted in the NetMeeting/Remote Assistance/Remote Desktop Features terms below, you may not use a Client to use, access, display or run the SOFTWARE, the SOFTWARE's user interface or other executable software residing on the INSTRUMENT.
- If you use the INSTRUMENT to access or utilize the services or functionality of Microsoft Windows Server products (such as Microsoft Windows NT Server 4.0 (all editions) or Microsoft Windows 2000 Server (all editions)), or use the INSTRUMENT to permit workstation or computing devices to access or utilize the services or functionality of Microsoft Windows Server products, you may be required to obtain a Client Access License for the INSTRUMENT and/or each such workstation or computing device. Please refer to the end user license agreement for your Microsoft Windows Server product for additional information.
- **Restricted Uses.** The SOFTWARE is not designed or intended for use or resale in hazardous environments requiring fail-safe performance, such as in the operation of nuclear facilities, aircraft navigation or communication systems, air traffic control, or other devices or systems in which a malfunction of the SOFTWARE would result in foreseeable risk of injury or death to the operator of the device or system, or to others.
- **Restricted Functionality.** You are licensed to use the SOFTWARE to provide only the limited functionality (specific tasks or processes) for which the INSTRUMENT has been designed and marketed by

[ADVANTEST]. This license specifically prohibits any other use of the software programs or functions, or inclusion of additional software programs or functions, on the INSTRUMENT.

- **Security Updates.** Content providers are using the digital rights management technology ("Microsoft DRM") contained in this SOFTWARE to protect the integrity of their content ("Secure Content") so that their intellectual property, including copyright, in such content is not misappropriated. Owners of such Secure Content ("Secure Content Owners") may, from time to time, request MS, Microsoft Corporation or their subsidiaries to provide security related updates to the Microsoft DRM components of the SOFTWARE ("Security Updates") that may affect your ability to copy, display and/or play Secure Content through Microsoft software or third party applications that utilize Microsoft DRM. You therefore agree that, if you elect to download a license from the Internet which enables your use of Secure Content, MS, Microsoft Corporation or their subsidiaries may, in conjunction with such license, also download onto your INSTRUMENT such Security Updates that a Secure Content Owner has requested that MS, Microsoft Corporation or their subsidiaries distribute. MS, Microsoft Corporation or their subsidiaries will not retrieve any personally identifiable information, or any other information, from your INSTRUMENT by downloading such Security Updates.
- **NetMeeting/Remote Assistance/Remote Desktop Features.** The SOFTWARE may contain NetMeeting, Remote Assistance, and Remote Desktop technologies that enable the SOFTWARE or other applications installed on the INSTRUMENT to be used remotely between two or more computing devices, even if the SOFTWARE or application is installed on only one INSTRUMENT. You may use NetMeeting, Remote Assistance, and Remote Desktop with all Microsoft products; provided however, use of these technologies with certain Microsoft products may require an additional license. For both Microsoft products and non-Microsoft products, you should consult the license agreement accompanying the applicable product or contact the applicable licensor to determine whether use of NetMeeting, Remote Assistance, or Remote Desktop is permitted without an additional license.
- **Consent to Use of Data.** You agree that MS, Microsoft Corporation and their affiliates may collect and use technical information gathered in any manner as part of product support services related to the SOFTWARE. MS, Microsoft Corporation and their affiliates may use this information solely to improve their products or to provide customized services or technologies to you. MS, Microsoft Corporation and their affiliates may disclose this information to others, but not in a form that personally identifies you.
- || **Internet Gaming/Update Features.** If the SOFTWARE provides, and you choose to utilize, the Internet gaming or update features within the SOFTWARE, it is necessary to use certain computer system, hardware, and software information to implement the features. By using these features, you explicitly authorize MS, Microsoft Corporation and/or their designated agent to use this information solely to improve their products or to provide customized services or technologies to you. MS or Microsoft Corporation may disclose this information to others, but not in a form that personally identifies you.
- **Internet-Based Services Components.** The SOFTWARE may contain components that enable and facilitate the use of certain Internet-based services. You acknowledge and agree that MS, Microsoft Corporation or their affiliates may automatically check the version of the SOFTWARE and/or its components that you are utilizing and may provide upgrades or supplements to the SOFTWARE that may be automatically downloaded to your INSTRUMENT.
- || **Links to Third Party Sites.** The SOFTWARE may provide you with the ability to link to third party sites through the use of the SOFTWARE. The third party sites are not under the control of MS, Microsoft Corporation or their affiliates. Neither MS nor Microsoft Corporation nor their affiliates are responsible for (i) the contents of any third party sites, any links contained in third party sites, or any changes or updates to third party sites, or (ii) webcasting or any other form of transmission received from any third party sites. If the SOFTWARE provides links to third party sites, those links are provided to you only as a convenience, and the inclusion of any link does not imply an endorsement of the third party site by MS, Microsoft Corporation or their affiliates.
- **Additional Software/Services.** The SOFTWARE may permit [ADVANTEST], MS, Microsoft Corporation or their affiliates to provide or make available to you SOFTWARE updates, supplements, add-on components, or Internet-based services components of the SOFTWARE after the date you obtain your initial copy of the SOFTWARE ("Supplemental Components").
- || If [ADVANTEST] provides or makes available to you Supplemental Components and no other EULA terms are provided along with the Supplemental Components, then the terms of this EULA shall apply.
- If MS, Microsoft Corporation or their affiliates make available Supplemental Components, and no other EULA terms are provided, then the terms of this EULA shall apply, except that the MS, Microsoft Corporation or affiliate entity providing the Supplemental Component(s) shall be the licensor of the Supplemental Component(s).

[ADVANTEST], MS, Microsoft Corporation and their affiliates reserve the right to discontinue any Internet-based services provided to you or made available to you through the use of the SOFTWARE.

This EULA does not grant you any rights to use the Windows Media Format Software Development Kit ("WMFSDK") components contained in the SOFTWARE to develop a software application that uses Windows Media technology. If you wish to use the WMFSDK to develop such an application, visit <http://msdn.microsoft.com/workshop/imedia/windowsmedia/sdk/wmsdk.asp>, accept a separate license for the WMFSDK, download the appropriate WMFSDK, and install it on your system.



### 3. SETUP

This chapter explains how to set up this instrument on delivery. Topics covered in this chapter are:

- 3.1 Unpacking Inspection
- 3.2 Locating This Instrument
- 3.3 Connecting Accessories
- 3.4 Supply Description
- 3.5 Operation Check

#### 3.1 Unpacking Inspection

When the product is delivered, check it for its appearance and accessories included by following these steps:

1. Check to see if the box or the cushioning material in which the product was shipped has been damaged during transit.

---

**IMPORTANT:** *If the box or the cushioning material is found damaged, leave them in their original condition until the inspection described below completes.*

---

2. Check the product surfaces for any damage.

---

**WARNING:** *Do not power on this instrument if the cover, panels (front and rear), LCD display, power switch, connector or any other key component is found damaged. Electrical shock hazards could result from using damaged components.*

---

3. Make sure that all of the standard accessories are included and they are free from any damage, in accordance with the List of Table 3-1 Standard Accessories (OPT72).

Contact your dealer or us in any of the following situations:

- The box or the cushioning material in which the product was shipped was damaged during transit, or there is evidence of a massive force having been applied to the cushioning material.
- The product surfaces are damaged.
- One or more standard accessories are missing or damaged.
- Defects have been detected in a subsequent product verification test.

Table 3-1 Standard Accessories (OPT72)

Name	Model	Quantity
R3681 Series OPT72 User's Guide	ER3681OPT72	1
Input cable (50 $\Omega$ )	A01037-1500	1
N (m)-BNC (f) adapter	JUG-201A/U	1
SMA (m)-BNC (f) adapter	HRM-517	2

3.2 Locating This Instrument

**3.2 Locating This Instrument**

This section describes the installation environment in which this instrument runs successfully.

**3.2.1 Operating Environment**

This instrument should only be used in a place that satisfies the following conditions:

- Ambient temperature: +5 °C to +40 °C (operating temperature)  
-20 °C to +60 °C (storage temperature range)
- Relative humidity: RH80% or less (no condensation)
- An area free from corrosive gas
- An area away from direct sunlight
- A dust-free area
- An area free from vibrations
- A low noise area

Although this instrument has been designed to withstand a certain amount of noise riding on the AC power line, it should be used in an area of low noise.

Use a noise filter when ambient noise is unavoidable.

- An area allowing unobstructed airflow

There is an exhaust-cooling fan on the rear panel and exhaust vents on both sides and the bottom (toward the front) of this instrument. Never block these vents. The resulting internal temperature rise will affect measurement accuracy. Keep the rear panel 10 centimeters away from the wall. In addition, do not attempt to use this instrument when it is standing on its rear panel or on either side panel.

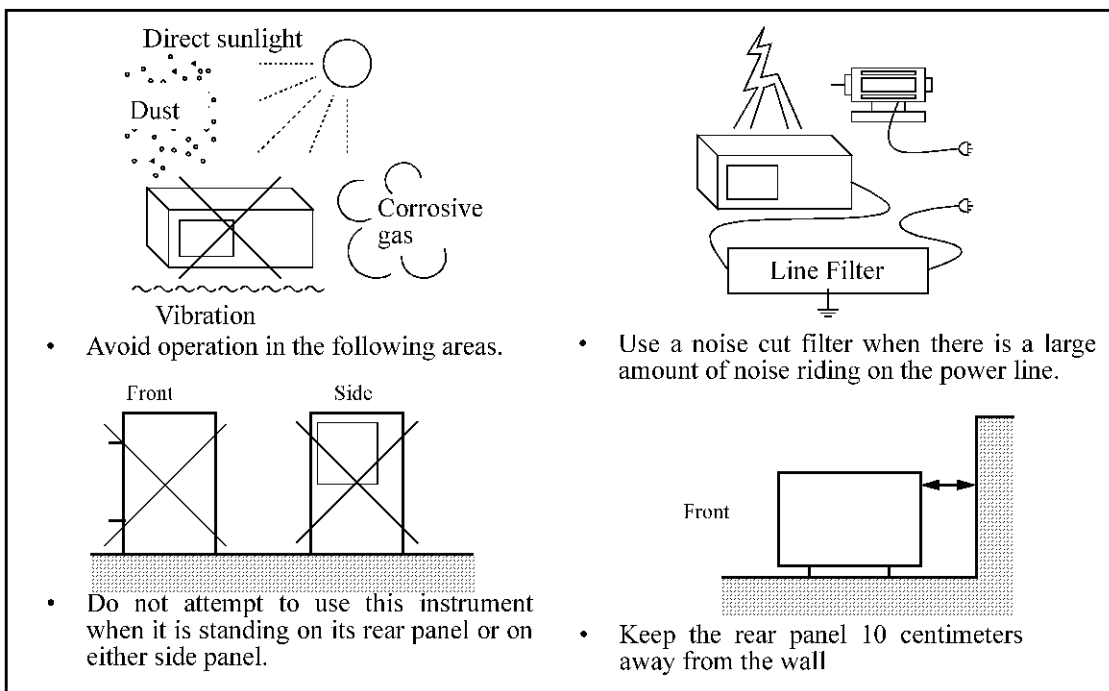

Figure 3-1 Operating Environment



### 3.2.2 Prevention of Electrostatic Buildup

To prevent damage to semiconductor parts from electrostatic discharge (ESD), the precautions shown below should be taken. We recommend that two or more countermeasures are combined to provide adequate protection from ESD.

(Static electricity can easily be built up when a person moves or an insulator is rubbed.)

Table 3-2 ESD Countermeasures

Operator	Use a wrist strap (see Figure 3-2).
Floor in the work area	Installation of a conductive mat, the use of conductive shoes, and grounding (see Figure 3-3).
Workbench	Installation of a conductive mat and grounding (see Figure 3-4).

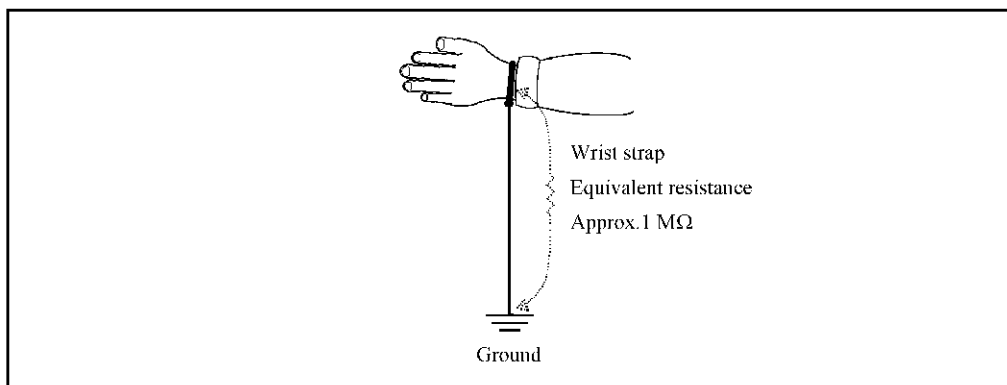

Figure 3-2 Countermeasures for Static Electricity of Human Body

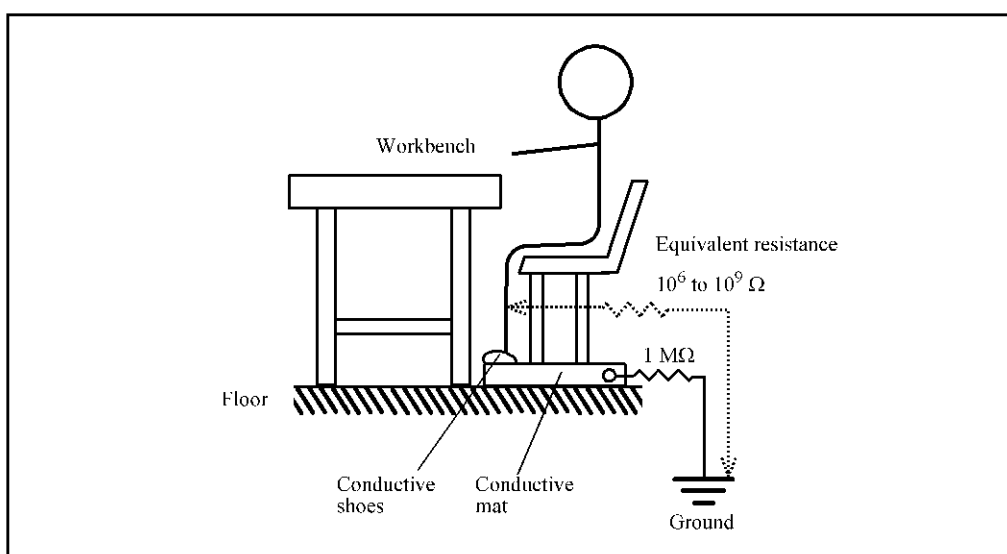

Figure 3-3 Countermeasures for Static Electricity on Work Floor

3.2.2 Prevention of Electrostatic Buildup

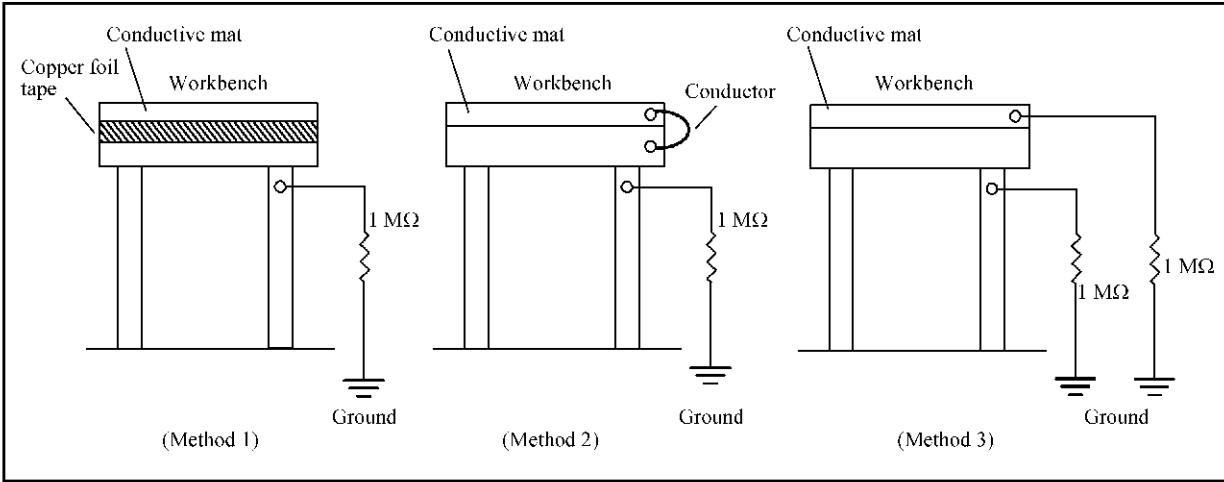

Figure 3-4 Countermeasures for Static Electricity on Workbench

### 3.3 Connecting Accessories

This section explains how to connect accessories to this instrument to run it.

#### 3.3.1 Connecting the Keyboard and Mouse

Connect the keyboard and mouse to their respective front-panel connectors (KEYBOARD and MOUSE connectors).

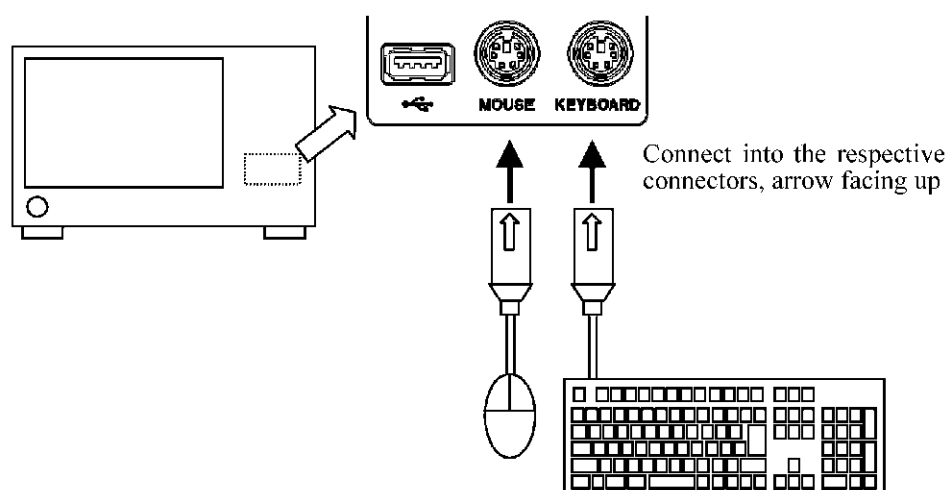

Figure 3-5 Connecting the Keyboard and Mouse

---

**CAUTION:** *The keyboard and mouse must be connected before turning on this instrument.*

---

3.4 Supply Description

**3.4 Supply Description**

This section explains how to check the power supply specifications and connect the power cable.

**3.4.1 Check the supply power**

Table 3-3 summarizes the power supply specifications for this instrument. Make sure that the power supply available to this instrument meets these specifications.

Table 3-3 Power Supply Specifications

	100 VAC Operation	200 VAC Operation	Remarks
Input voltage range	90 V to 132 V	198 V to 250 V	Automatically switches between input levels of 100 VAC and 200 VAC.
Frequency range	47 Hz to 63 Hz		
Power consumption	450 VA or below		

---

**WARNING:** *Be sure to provide a power supply that meets the specified power supply specifications for this instrument. Failure to meet the specifications could cause damage to this instrument.*

---

**3.4.2 Connecting the Power Cable**

This instrument comes with a three-core power cable with a grounding conductor. To guard against electrical shock hazards, ground this instrument by plugging the power cable into a three-pole power outlet.

1. Check the power cable included with this instrument for any damage.

---

**WARNING:** *Never use a damaged power cable. Electrical shock hazards could result.*

---

2. Plug one end of the power cable included with this instrument into the AC power connector on this instrument rear panel and the other into a three-pole power outlet having a protecting grounding terminal (see Figure 3-6).

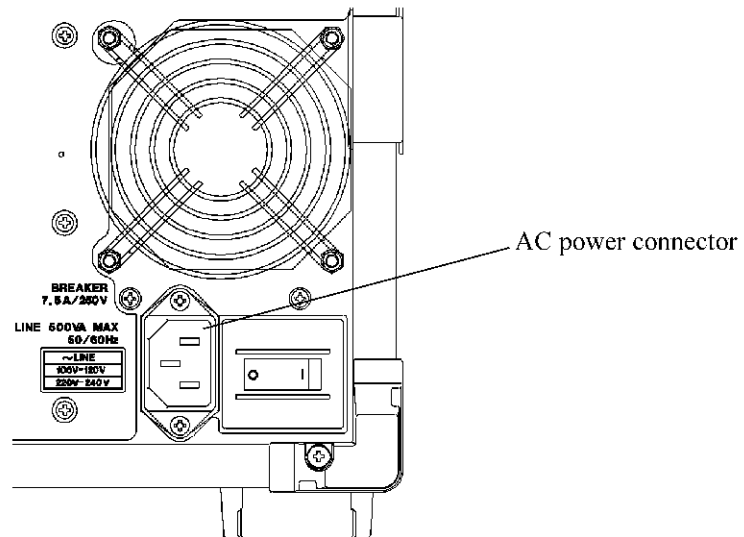

Figure 3-6 Connecting the Power Cable

---

**WARNING:**

1. Use a power cable rated for the voltage being used. Be sure however to use a power cable conforming to the safety standards of your country when using this instrument overseas (Refer to "Safety Summary").
  2. Plug the power cable into a three-pole power outlet having a protecting grounding terminal to guard against electrical shock hazards. Use of an extension cord without a protecting grounding terminal would override the protective grounding.
-

### 3.5 Operation Check

## 3.5 Operation Check

This section explains how to make a simple operation check on this instrument by using its built-in autocalibration feature. To verify that this instrument runs correctly, follow these steps:

Starting up this instrument

1. Connect the power cable as instructed in 3.4.2 "Connecting the Power Cable."
2. Switch on the power breaker on the rear panel.  
Then wait for 3 seconds or more.
3. Press the **POWER** switch to switch on the power.

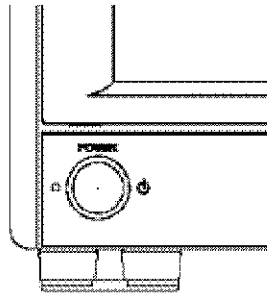

Figure 3-7 POWER Switch

---

**CAUTION:**

1. *If this instrument is abruptly powered off while in operation, such as by pulling the power cable out of position, the hard disk drive could fail. Even when the hard disk drive does not fail, Scandisk launches to check for possible corruptions in the data stored on it the next time this instrument starts up.*
  2. *About Scandisk*  
*If this instrument has been powered off without being shut down, Scandisk will launch to check for corruptions automatically. Do not abort Scandisk while it is running. If Scandisk locates corruptions, take appropriate remedial action as recommended by the display messages. The software in this instrument resumes automatically when Scandisk ends.*
- 

4. The power-on diagnostic program launches to carry out self-diagnostics.  
The self-diagnostics take about 1 minute to complete.
5. The initial screen shown in Figure 3-8 is displayed unless this instrument is tested faulty.

The initial screen may give a different look from Figure 3-8, depending on the settings in effect the last time this instrument was powered off.



3.5 Operation Check

Executing auto calibration

6. Touch the **[Config]** button on the menu bar and select **[SG+AWG Option]** on the drop down menu. The screen shown in Figure 3-9 will be displayed.

Depending on the state of setting when the power supply was turned off last time, the display screen may differ from Figure 3-9.

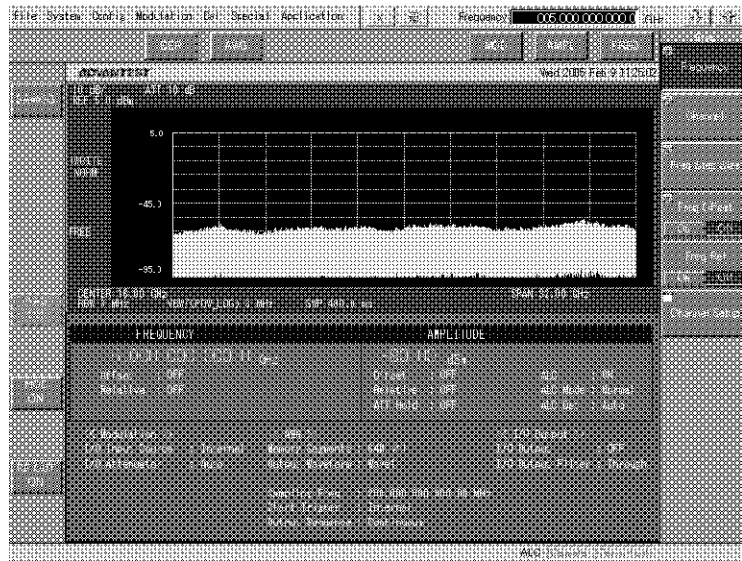

Figure 3-9 SG+AWG Initial Setting Screen

---

**IMPORTANT:** Execute auto-calibration after it has warmed up for 30 minutes or longer.

---

7. Touch the **[Cal]** button on the menu bar of this instrument and select **[AWG Cal]** on the drop down menu.
8. Auto calibration will be executed.  
It takes approximately 20 seconds to complete auto calibration.
9. Verify that no error message is displayed as the result of auto calibration.

---

**MEMO:** If any error message is displayed by auto calibration, refer to the **APPENDIX** of the **R3681 Series OPT72 Digital Signal Generator Module User's Guide**.

---

Switching off power

10. Press the **POWER** switch of this instrument.  
The final processing of the system is performed and the power is automatically turned off.



## 4. EXAMPLES OF OPERATIONS

This chapter describes the functions of each part of the panels and screen of this option, and basic operations.

### 4.1 Description of the Panels and the Screen

The following sections describe the name and function of each component on the front panel, displays on the screen, and the rear panel.

#### 4.1.1 The Name and Functions of Each Component on the Front Panel

This subsection describes the name and function of each component on the front panel.

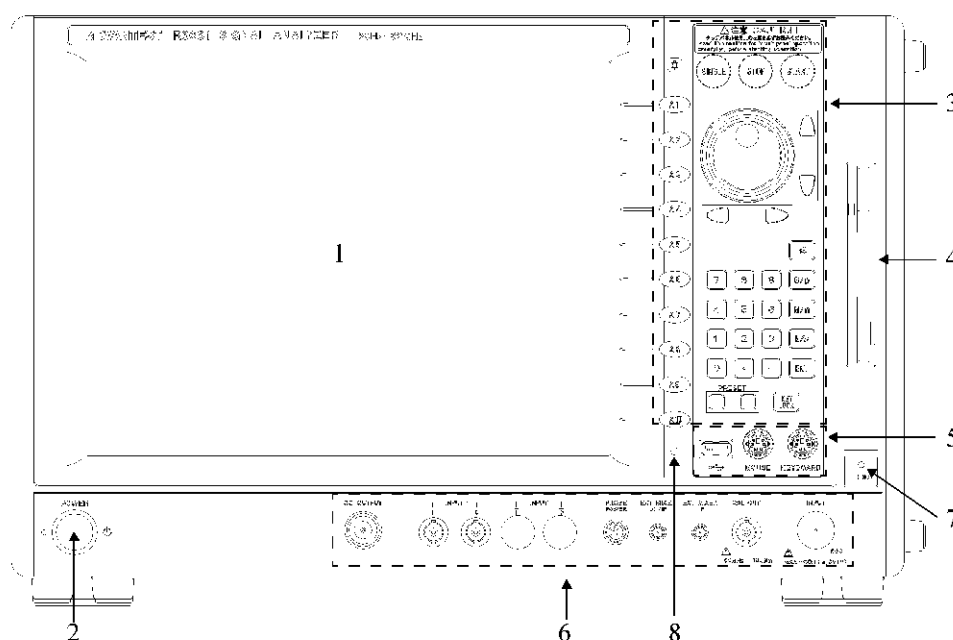

Figure 4-1 Front Panel

- |                         |   |
|-------------------------|---|
| 1. Touch screen display | Displays measurement data, setting conditions, and other information items. The setting conditions can be changed by the functions of the touch screen. |
| 2. POWER switch         | Turns on or off the power of this instrument. When you turn off this switch, the system terminates before power turns off.                              |
| 3. Entry key block      | Used for changing settings  |
| 4. Floppy disk drive    | A 3.5" floppy disk drive  |
| 5. I/F connector block  | An I/F connector block for a keyboard and a mouse   |
| 6. I/O connector block  | An I/O connector block for measurement  |

4.1.1 The Name and Functions of Each Component on the Front Panel

- 7. HDD (hard disk drive) access lamp  
Lights up while access is being made to the hard disk
- 8. Power lamp  
Lights up while power is on

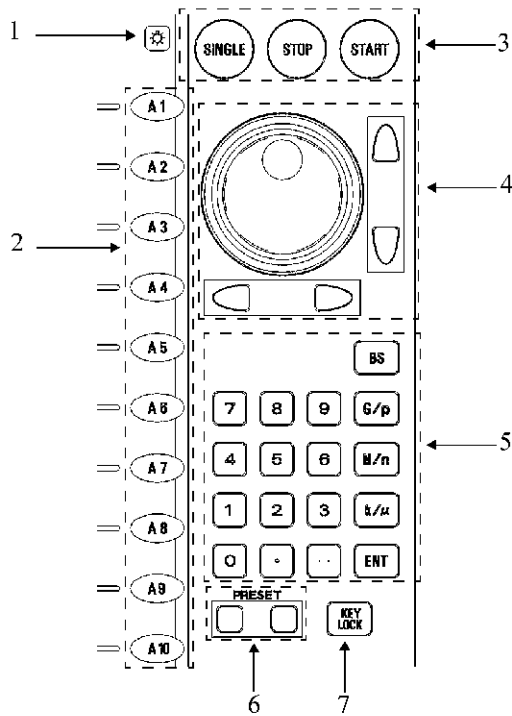

Figure 4-2 Entry Key Block

- 1. Back light key  
Turns on or off the display back light
- 2. Application keys  
Select soft menu bars for display
- 3. Program keys  
Control measurement.  
SINGLE: Press for a single measurement.  
STOP: Press to stop continuous measurement.  
START: Press to start continuous measurement.
- 4. Data knob and step keys  
A data knob and step keys

---

**IMPORTANT:** Changing of the settings for numeric entry may fail if you continuously press the data knob too quickly to allow the system to follow.

---

4.1.1 The Name and Functions of Each Component on the Front Panel

- |    |              |   |
|----|--------------|---|
| 5. | Ten-key pad  | Used to enter numeric values<br>BS: Back space key<br>G/p: Units key of GHz for frequency and psec for time<br>M/n: Units key of MHz for frequency and nsec for time<br>K/μ: Units key of kHz for frequency and μsec for time<br>ENT: Basic units key of Hz for frequency and msec for time |
| 6. | Preset keys  | The initialization key of this instrument<br>To initialize the instrument, press the left key while you are pressing the right key.   |
| 7. | Key lock key | The toggle key that locks and unlocks key entry]  |

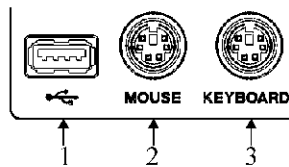

Figure 4-3 I/F Connector Block

- |    |                    |                                      |
|----|--------------------|--------------------------------------|
| 1. | USB connector      | A USB connector for accessories      |
| 2. | MOUSE connector    | A mouse connector                    |
| 3. | KEYBOARD connector | A connector for an external keyboard |

**IMPORTANT:** *Connect the mouse and keyboard before power-on.*

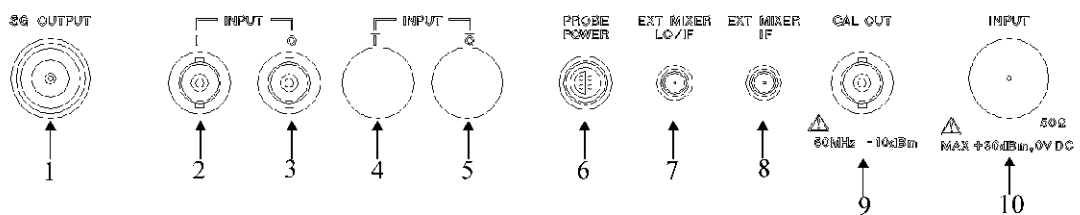

Figure 4-4 I/O Connector Block

- |    |                       |  |
|----|-----------------------|--|
| 1. | SG OUTPUT connector   | The output connector for the RF signal.        |
| 2. | INPUT I connector     | The input connector for the base band I signal |
| 3. | INPUT Q connector     | The input connector for the base band Q signal |
| 4. | INPUT /I connector    | Reserved for options                           |
| 5. | INPUT /Q connector    | Reserved for options                           |
| 6. | PROBE POWER connector | Power connector for the probe (±15 V output)   |

4.1.1 The Name and Functions of Each Component on the Front Panel

- |                           |   |
|---------------------------|---|
| 7. EXT MIXER LO/IF        | Reserved for options<br>Connects an external mixer to expand the frequency range for measurement (supports two ports)   |
| 8. EXT MIXER IF connector | Reserved for options<br>Connects an external mixer to expand the frequency range for measurement (supports three ports) |
| 9. CAL OUT connector      | Outputs calibration signals   |
| 10. INPUT connector       | Receives measurement signals  |

---

**CAUTION:** *Do not apply an RF level or direct current that exceeds the respective limit value to the INPUT connector. If you do, the input attenuator or the mixer may burn out.*

---

### 4.1.2 Name and Function of Each Part of the Screen

This section describes the names and functions of the screen of this option.

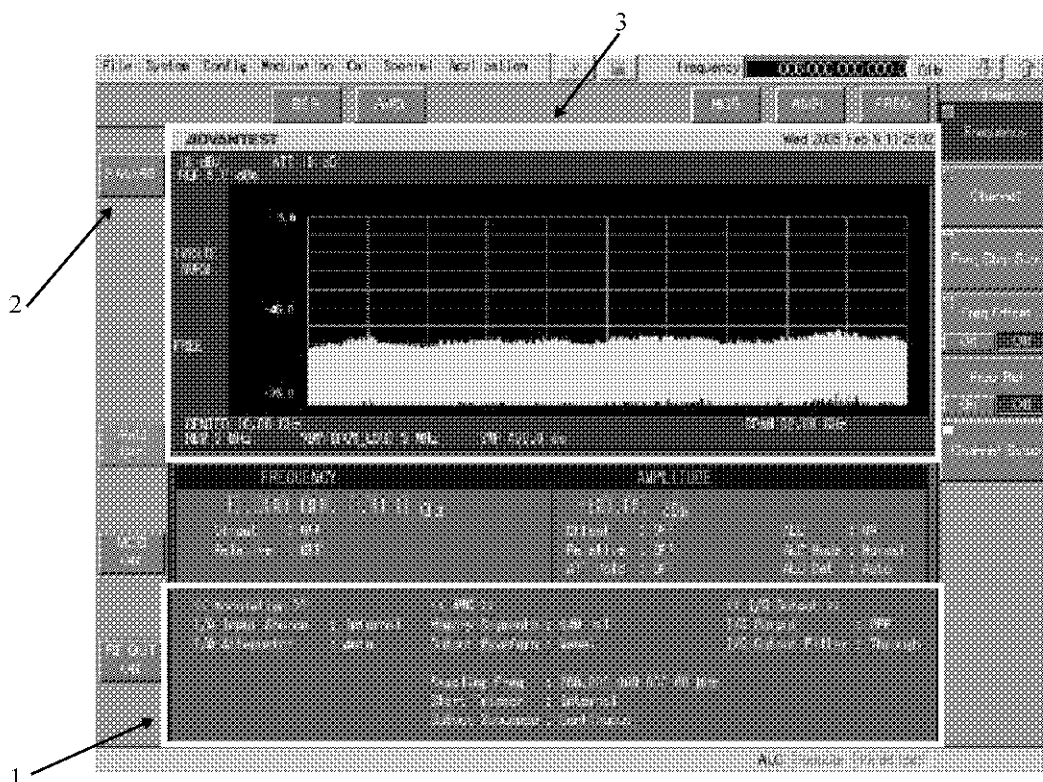

Figure 4-5 Screen Display

- |    |                                |  |
|----|--------------------------------|--|
| 1. | Display of SG+AWG setting list | Displays the setting state for the main setting items of SG+AWG.               |
| 2. | Active application button      | Switches between SA and SG+AWG.  |
| 3. | SA screen                      | Display area for SA. For more information, refer to R3681 Series User's Guide. |

---

**IMPORTANT:** The AWG screen is not displayed when SA is selected by using the active application button.  
To display the AWG screen, press the active application button and select AWG.

---

4.1.3 The Name and Functions of Each Component on the Rear Panel

4.1.3 The Name and Functions of Each Component on the Rear Panel

This subsection describes the name and function of each component on the rear panel.

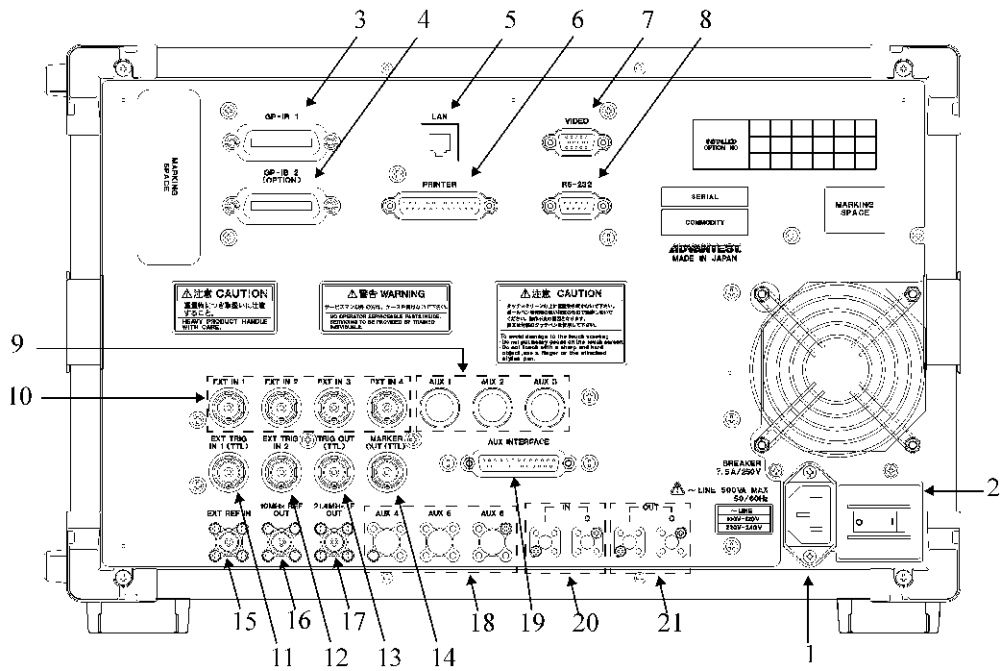

Figure 4-6 Rear Panel

- 1. to 9. Refer to the R3681 Series User's Guide.
- 10. EXT IN 1 connector      Inputs the clock of the BER counter (TTL level or LVTTTL level).
- EXT IN 2 connector      Inputs the data of the BER counter (TTL level or LVTTTL level).
- EXT IN 3 connector      Inputs the clock gate of the BER counter (TTL level or LVTTTL level).
- EXT IN 4 connector      Inputs the external trigger of the BER counter (TTL level or LVTTTL level).
- 11. to 13. Refer to the R3681 Series User's Guide.
- 14. MARKER OUT (TTL) connector      Outputs the signal of marker 2.
- 15. to 20. Refer to the R3681 Series User's Guide.
- 21. I OUT connector      Outputs the I signal.
- Q OUT connector      Outputs the Q signal.

## 4.2 Basic Operation

Refer to the R3681 Series User's Guide.

## 4.3 Operating Method

This section describes the following basic operating procedures so that you can familiarize yourself with operation of this option.

- 4.3.1 Operation from Waveform File Loading to I/Q Signal Output
- 4.3.2 Operation of BER Measurement

### 4.3.1 Operation from Waveform File Loading to I/Q Signal Output

This section describes operation procedures from waveform file loading to actual output of the I/Q signal.

[Sample waveform data file specifications]

Compliant standards: IEEE802.11a signal

[Targeted settings]

- Settings related to waveform data loading
 

Memory Segments:	16M Word ×4
Load Waveform Map Number:	Wave1
Auto Load:	ON
- Settings related to waveform output
 

Sampling Freq.:	100 MHz
Output Waveform Select:	Wave1
Marker1:	ON
Marker2:	ON
Start Trigger:	Internal
Output Sequence:	Continuous
- Settings related to markers
 

Mode:	Sequencer
Marker1 Polarity:	Pos
Marker1 Start Offset Period:	0
Marker1 High Period:	100
Marker1 Low Period:	100
Marker1 Loop Number:	1
Marker2 Polarity:	Pos
Marker2 Start Offset Period:	0
Marker2 High Period:	100

4.3.1 Operation from Waveform File Loading to I/Q Signal Output

- |                      |     |
|----------------------|-----|
| Marker2 Low Period:  | 100 |
| Marker2 Loop Number: | 1   |
- Settings related to I/Q output

I/Q Output:	Fix Gain Path(1V <sub>p,p</sub> )
I/Q Offset:	0 mV
I/Q Output Filter:	Through

[Required equipment]

R3681 series + Option 72

Conversion adapter: SMA (m)-BNC (f)

Output cable: BNC (m)-BNC (m)

Turning on the power supply

1. Verify that the power supply circuit breaker on the rear panel is OFF.
2. Connect the attached power cable to the AC power connector on the rear panel.
3. Connect the power cable to an electrical outlet.
4. Turn ON the power supply circuit breaker on the rear panel.  
After turning ON the power supply circuit breaker, wait for three seconds or longer.
5. Turn ON the power switch on the front panel.  
When the self-test is completed, the screen returns to the startup screen.

---

**MEMO:** *The display after turning ON the power supply differs depending on the state of last use.*

---



### Initialization

Initializes the settings of this instrument.

6. Touch **[Special]** on the menu bar and select **[Preset]→[All]**.  
Initial setting conditions are loaded.

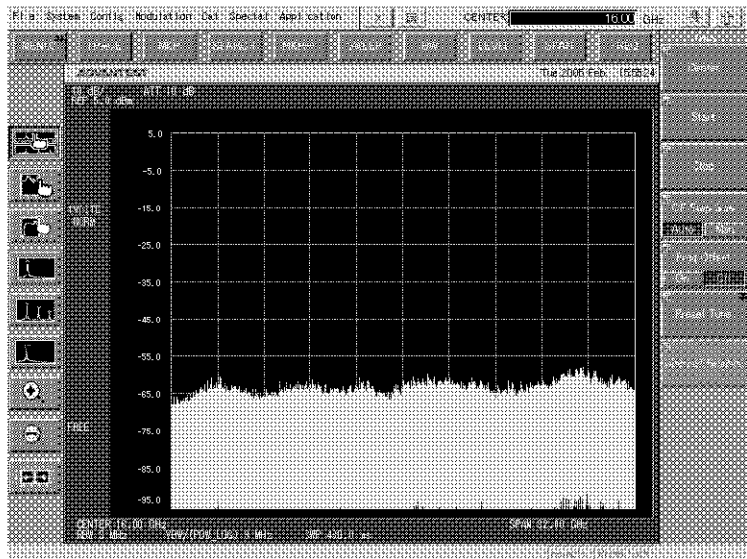

Figure 4-7 Initial Setting Screen

4.3.1 Operation from Waveform File Loading to I/Q Signal Output

Device connection

7. Attach the SMA(m)-BNC(f) adapters to each I/Q output connector on the rear panel. Connect to the DUT with BNC (m)-BNC (m) cables.

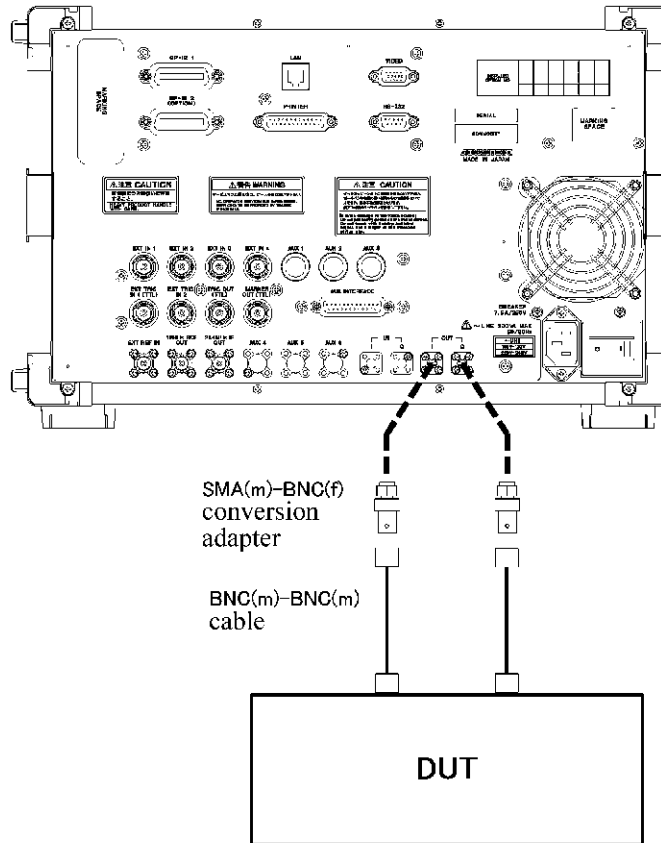

Figure 4-8 Connection Diagram

AWG setting

8. Touch [**Config**] on the menu bar and select [**SG+AWG Option**].  
The SG+AWG screen will be displayed.

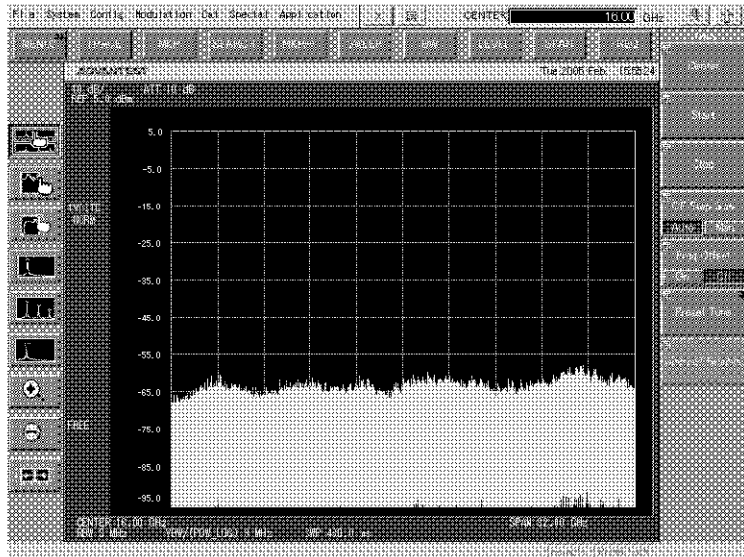

Figure 4-9 SG+AWG Screen

---

**MEMO:** The display after turning ON the power supply differs depending on the state of last use.

---

9. Touch [**Cal**] on the menu bar and select [**AWG Cal**] to carry out calibration.

---

**IMPORTANT:** Execute auto-calibration after turning on the power supply and letting it warm up for 30 minutes or longer.

---

10. Touch the {**AWG**} button on the function bar.
11. Touch the **Waveform Setup** key on the soft menu bar.  
The [**Waveform Setup**] dialog box will be displayed.

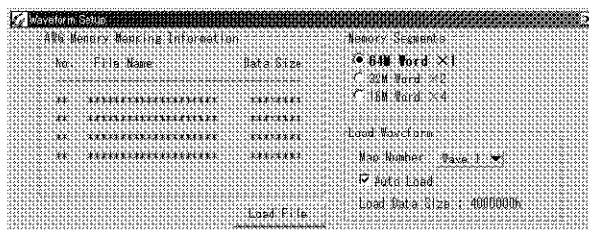

Figure 4-10 [Waveform Setup] Dialog Box

4.3.1 Operation from Waveform File Loading to I/Q Signal Output

12. Touch **[16M Word × 4]** of **[Memory Segments]** on the **[Waveform Setup]** dialog box.  
A message box to confirm whether or not it is okay to change **[Memory Segments]** will be displayed. Touch the OK button.

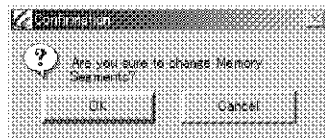

Figure 4-11 **[Memory Segments]** Change Inquiry Message Box

13. Select Wave1 from **[Map Number]** of **[Load Waveform]** in the **[Waveform Setup]** dialog box.
14. Verify that the **[Auto Load]** check box of **[Load Waveform]** on the **[Waveform Setup]** dialog box has been checked.  
If it is not checked, touch the check box to check it.
15. Touch the **[Load File]** button in the **[Waveform Setup]** dialog box.  
The **[Select Waveform]** dialog box will be displayed.

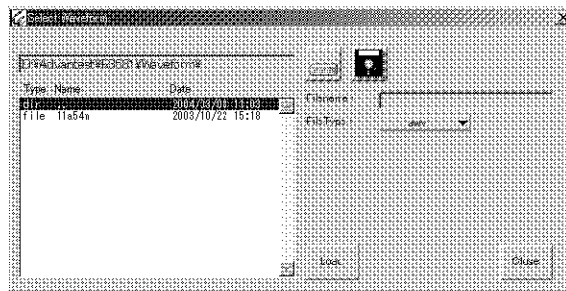

Figure 4-12 **[Select Waveform]** Dialog Box

16. Select the file name “11a54m” from the **[Select Waveform]** dialog box.  
The selected file name will be displayed in the **[Filename]** text box.
17. Touch the **[Load]** button on the **[Select Waveform]** dialog box.  
File loading will be started.  
When file loading is completed, the **[Select Waveform]** dialog box will disappear from the screen.

**CAUTION:** If the file size is large, loading takes considerable time.

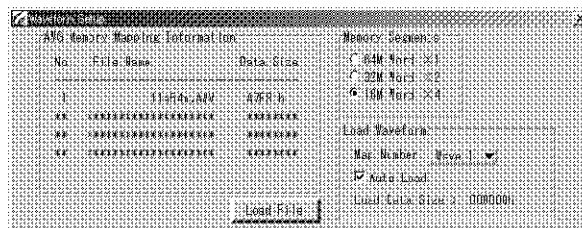
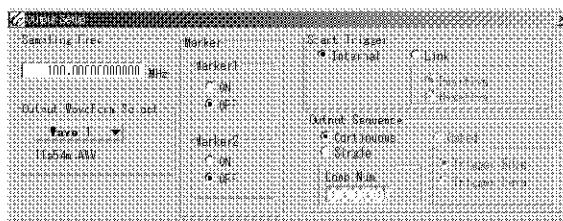

Figure 4-13 **[Waveform Setup]** Dialog Box

## 4.3.1 Operation from Waveform File Loading to I/Q Signal Output

18. When the file is loaded, NO., the loaded file name and data size will be displayed in **[AWG Memory Mapping Information]** in the **[Waveform Setup]** dialog box. Check them for verification.
19. Touch the close button [×] on the **[Waveform Setup]** dialog box to close the dialog box.
20. Touch the **Output Setup** key on the soft menu bar.  
The **[Output Setup]** dialog box will be displayed.

Figure 4-14 **[Output Setup]** Dialog Box

21. Touch the **[Sampling Freq]** text box on the **[Output Setup]** dialog box.  
The set value is displayed in a black/white inverted state.
22. Input as **1**, **0**, **0**, **M/n** using the ten-key pad.  
The sampling frequency will be set to 100 MHz.
23. Select Wave1 from **[Output Waveform Select]** in the **[Output Setup]** dialog box.
24. Verify that the **[Marker1]** option button of **[Marker]** in the **[Output Setup]** dialog box is **[ON]**.  
If it is **[OFF]**, touch **[ON]**.
25. Verify that the **[Marker2]** option button of **[Marker]** in the **[Output Setup]** dialog box is **[ON]**.  
If it is **[OFF]**, touch **[ON]**.
26. Verify that the **[Start Trigger]** option button on the **[Output Setup]** dialog box is **[Internal]**.  
If the button is in another mode, touch **[Internal]**.
27. Verify that the **[Output Sequence]** option button on the **[Output Setup]** dialog box is set to **[Continuous]**.  
If the button is set in another mode, touch **[Continuous]**.
28. Touch the close button [×] on the **[Output Setup]** dialog box to close the dialog box.

4.3.1 Operation from Waveform File Loading to I/Q Signal Output

29. Touch the **Marker Setup** key on the soft menu bar.  
The **[Marker Setup]** dialog box will be displayed.

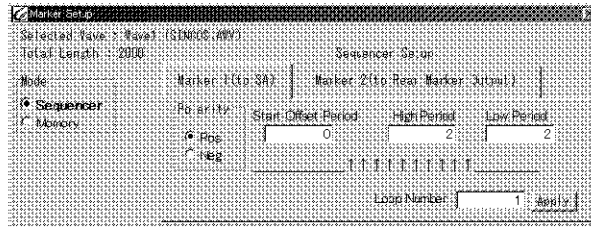

Figure 4-15 **[Marker Setup]** Dialog Box

30. Verify that the **[Mode]** option button on the **[Marker Setup]** dialog box is set to **[Sequencer]**.  
If **[Memory]** has been selected, change it to **[Sequencer]**.
31. Touch the **[Marker 1(to SA)]** tab.
32. Verify that the **[Polarity]** option button on the **[Marker 1(to SA)]** tab is set to **[Pos]**.  
If **[Neg]** has been selected, change it to **[Pos]**.
33. Touch the **[Start Offset Period]** text box on the **[Marker 1(to SA)]** tab.  
The set value is displayed in a black/white inverted state.
34. Input as **0**, **ENT** using the ten-key pad.  
0 will be input to the start offset period.
35. Touch the **[High Period]** text box on the **[Marker 1(to SA)]** tab.  
The set value is displayed in a black/white inverted state.
36. Input as **1**, **0**, **0**, **ENT** using the ten-key pad.  
100 will be input to the high period.
37. Touch the **[Low Period]** text box on the **[Marker 1(to SA)]** tab.  
The set value is displayed in a black/white inverted state.
38. Input as **1**, **0**, **0**, **ENT** using the ten-key pad.  
100 will be input to the low period.
39. Touch the **[Loop Number]** text box on the **[Marker 1(to SA)]** tab.  
The set value is displayed in a black/white inverted state.
40. Input as **1**, **ENT** using the ten-key pad.  
1 will be input to the loop number.
41. Press the **[Apply]** button on the **[Marker 1(to SA)]** tab.  
With the above steps, the values of the previously input **[Start Offset Period]**, **[High Period]**, **[Low Period]** and **[Loop Number]** are set.

42. Touch the **[Marker 2(to Rear Marker Output)]** tab.
43. Verify that the **[Polarity]** option button on the **[Marker 2(to Rear Marker Output)]** tab is set to **[Pos]**.  
If **[Neg]** has been selected, change it to **[Pos]**.
44. Touch the **[Start Offset Period]** text box on the **[Marker 2(to Rear Marker Output)]** tab.  
The set value is displayed in a black/white inverted state.
45. Input as **[0]**, **[ENT]** using the ten-key pad.  
0 will be input to the start offset period.
46. Touch the **[High Period]** text box on the **[Marker 2(to Rear Marker Output)]** tab.  
The set value is displayed in a black/white inverted state.
47. Input as **[1]**, **[0]**, **[0]**, **[ENT]** using the ten-key pad.  
100 will be input to the high period.
48. Touch the **[Low Period]** text box on the **[Marker 2(to Rear Marker Output)]** tab.  
The set value is displayed in a black/white inverted state.
49. Input as **[1]**, **[0]**, **[0]**, **[ENT]** using the ten-key pad.  
100 will be input to the low period.
50. Touch the **[Loop Number]** text box on the **[Marker 2(to Rear Marker Output)]** tab.  
The set value is displayed in a black/white inverted state.
51. Input as **[1]**, **[ENT]** using the ten-key pad.  
1 will be input to the loop number.
52. Press the **[Apply]** button on the **[Marker 2(to Rear Marker Output)]** tab.  
With the above steps, the values of the previously input **[Start Offset Period]**, **[High Period]**, **[Low Period]** and **[Loop Number]** are set.
53. Touch the close button **[×]** on the **[Marker Setup]** dialog box to close the dialog box.

4.3.1 Operation from Waveform File Loading to I/Q Signal Output

54. Touch the **I/Q Output** key on the soft menu bar.  
The **I/Q Output Control** dialog box will be displayed.

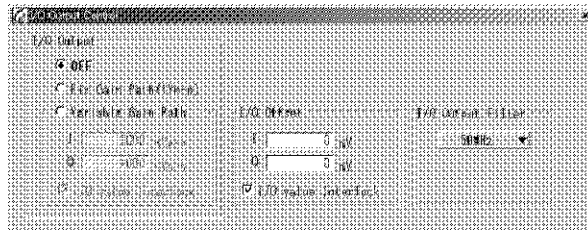

Figure 4-16 **I/Q Output Control** Dialog Box

55. Touch the **Fix Gain Path** of the **I/Q Output** option button on the **I/Q Output Control** dialog box.
56. Verify that the **I/Q value Interlock** check box of **I/Q Offset** on the **I/Q Output Control** dialog box has been checked.  
If it is not checked, touch the **I/Q value Interlock** check box to check it.
57. Touch the **I** text box of **I/Q Offset** on the **I/Q Output Control** dialog box.  
The set value is displayed in a black/white inverted state.
58. Input as **0**, **ENT** using the ten-key pad.  
0 mV will be set to the offsets of each of I and Q.
59. Select Through for **I/Q Output Filter** on the **I/Q Output Control** dialog box.
60. Touch the close button [×] on the **I/Q Output Control** dialog box to close the dialog box.
61. The I and Q signals are output by pressing the **AWG ON** button located below the active application button.  
Re-press the **AWG ON** button to stop the I/Q output.



### 4.3.2 Operation of BER Measurement

This section describes the BER measuring procedures using the BER counter.

[Targeted settings]

Stop on Error:	OFF
Measure Bit Length:	1000 bits
Cycle Count:	1
PRBS:	PN9
Data Polarity:	Positive
Clock Slope:	Rising
Clock Gate:	Off
Start Trigger:	Internal
Sync Mode:	Auto
BER Display:	%
Pass/Fail:	Off

[Required equipment]

R3681 series + Option 72  
Output cable: BNC (m)-BNC (m)

Turning on the power supply

---

**IMPORTANT:** After turning on the power supply, let it warm up for 30 minutes or longer.

---

1. Verify that the power supply circuit breaker on the rear panel is OFF.
2. Connect the attached power cable to the AC power connector on the rear panel.
3. Connect the power cable to an electrical outlet.
4. Turn ON the power supply circuit breaker on the rear panel.  
After turning ON the power supply circuit breaker, wait for three seconds or longer.
5. Turn ON the power switch on the front panel.  
When the self-test is completed, the screen returns to the startup screen.

---

**MEMO:** The display after turning ON the power supply differs depending on the state of last use.

---

4.3.2 Operation of BER Measurement

Initialization

Initializes the settings of this instrument.

6. Touch **[Special]** on the menu bar and select **[Preset]→[All]**.  
Initial setting conditions are loaded.

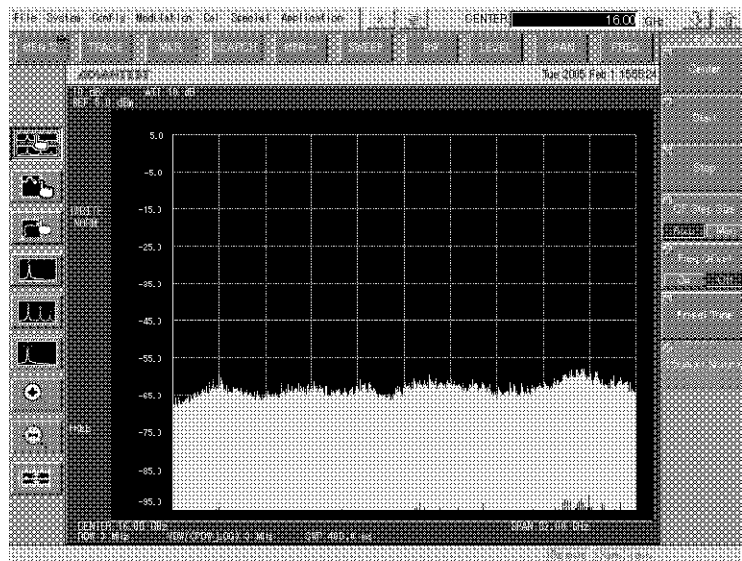

Figure 4-17 Initial Setting Screen

## Device connection

7. Connect the EXT1 input connector on the rear panel to the CLOCK output of the DUT with BNC(m)-BNC(m).

Connect the EXT2 input connector on the rear panel to the DATA output of the DUT with BNC(m)-BNC(m).

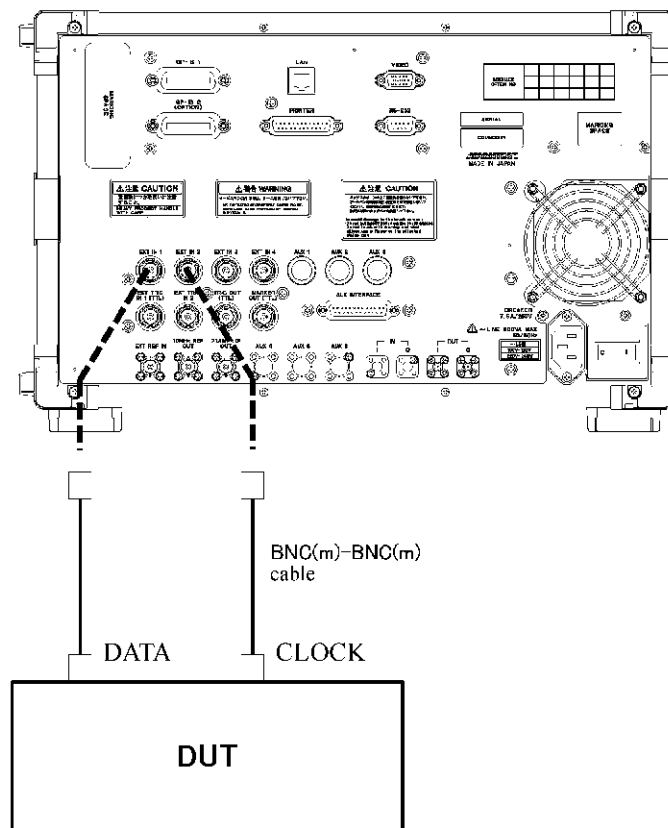

Figure 4-18 Connection Diagram

4.3.2 Operation of BER Measurement

BER setting

8. Touch **[Config]** on the menu bar and select **[SG+AWG Option]**.  
Selecting **[SG+AWG Option]** will display the SG+AWG screen.

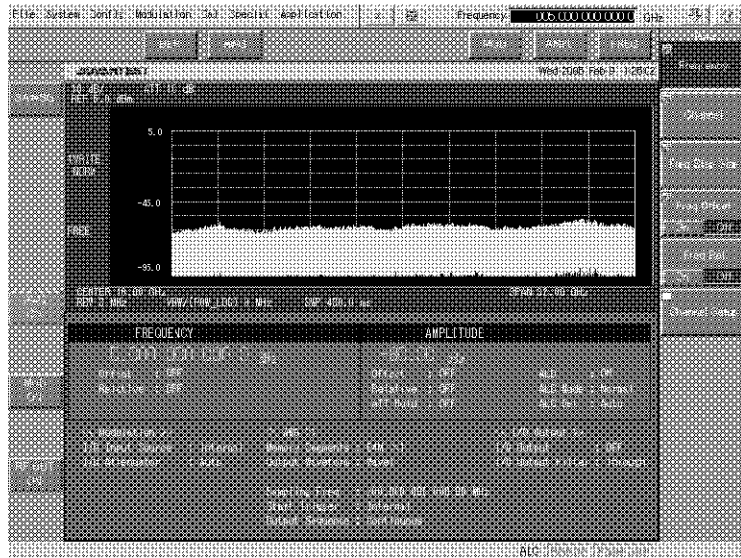

Figure 4-19 SG+AWG Screen

**MEMO:** The display after turning ON the power supply differs depending on the state of last use.

9. Touch the **{BER}** button on the function bar.  
The bit error rate measurement screen will be displayed.

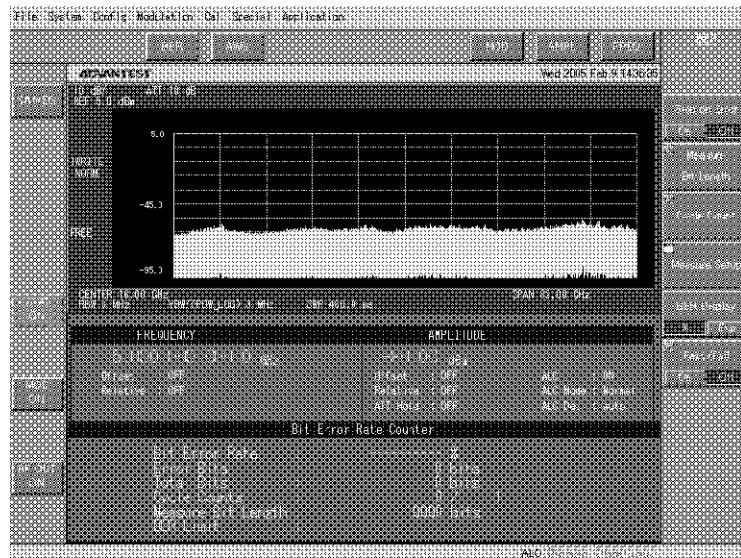

Figure 4-20 Bit Error Rate Measurement Screen

10. Verify that the **Stop on Error On/Off** key on the soft menu bar has been turned OFF.

If the **Stop on Error On/Off** key is ON, touch the **Stop on Error On/Off** key to turn it OFF.

11. Press the **Measure Bit Length** key on the soft menu bar.  
Entry box 2 will be displayed and inputting of the measuring bit length will become possible.
12. Press **1**, **0**, **0**, **0**, **ENT**.  
The measuring bit length will be set to 1000 bits.
13. Press the **Cycle Count** key on the soft menu bar.  
Entry box 2 will be displayed and inputting of the number of cycles becomes possible.
14. Press **1**, **ENT**.  
The number of cycles will be set to 1.
15. Press the **Measure Setup** key on the soft menu bar.  
The **[Bit Error Rate Counter Setup]** dialog box will be displayed.

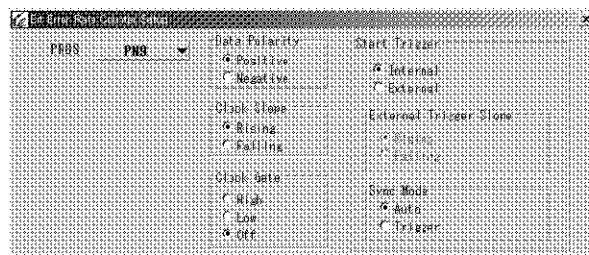

Figure 4-21 **[Bit Error Rate Counter Setup]** Dialog Box

16. Verify that **[PRBS]** in the **[Bit Error Rate Counter Setup]** dialog box has been set to PN9.  
If **[PRBS]** has not been set to PN9, set it to PN9.
17. Set the **[Data Polarity]** option button on the **[Bit Error Rate Counter Setup]** dialog box to either **[Positive]** or **[Negative]**, depending on the data polarity of the DUT.
18. Set the **[Clock Slope]** option button on the **[Bit Error Rate Counter Setup]** dialog box to either **[Rising]** or **[Falling]**, depending on the data output timing of the DUT.
19. Verify that the **[Clock Gate]** option button on the **[Bit Error Rate Counter Setup]** dialog box is **[Off]**.  
If the button is in another mode, touch **[Off]**.
20. Verify that the **[Start Trigger]** option button on the **[Bit Error Rate Counter Setup]** dialog box has been set to **[Internal]**.  
If the button has been set to **[External]**, touch **[Internal]**.

4.3.2 Operation of BER Measurement

21. Verify that the [Sync Mode] option button on the [Bit Error Rate Counter Setup] dialog box has been set to [Auto].  
If the button has been set to [Trigger], touch [Auto].
22. Touch the close button [×] on the [Bit Error Rate Counter Setup] dialog box to close the [Bit Error Rate Counter Setup] dialog box.
23. Verify that the **BER Display %/Exp** key on the soft menu bar has been set to %.  
If the **BER Display %/Exp** key has been set to Exp, touch the **BER Display %/Exp** key to set it to %.
24. Verify that the **Pass/Fail On/Off** key on the soft menu bar has been turned OFF.  
If the **Pass/Fail On/Off** key is ON, touch the **Pass/Fail On/Off** key to turn it OFF.
25. Pressing the **SINGLE** button of the program keys on the front panel will start bit error rate measurement.  
To stop the measurement, press the **STOP** button of the program keys.

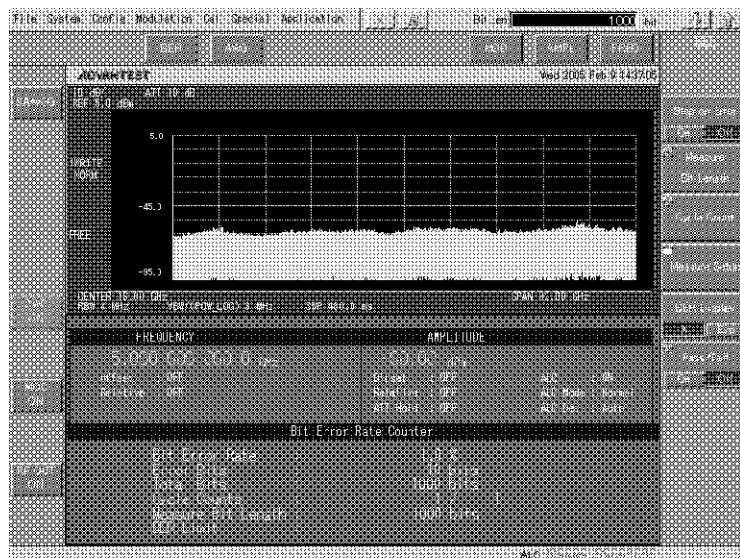

Figure 4-22 Bit Error Rate Measurement Result Screen

### 4.3.3 Operation of RF Signal Output

This section describes the procedure for operating the RF signal output.

[Sample waveform data file specifications]

Compliant standards: IEEE802.11a signal

[Targeted settings]

- Settings related to waveform data loading
 

Memory Segments:	16M Word × 4 Waveform
Load Waveform Map Number:	Wave1
Auto Load:	ON
- Settings related to waveform output
 

Sampling Freq.:	100 MHz
Output Waveform Select:	Wave 1
Marker1:	ON
Marker2:	ON
Start Trigger:	Internal
Output Sequence:	Continuous
- Settings related to markers
 

Mode:	Sequencer
Marker1 Polarity:	Pos
Marker1 Start Offset Period:	0
Marker1 High Period:	100
Marker1 Low Period:	100
Marker1 Loop Number:	1
Marker2 Polarity:	Pos
Marker2 Start Offset Period:	0
Marker2 High Period:	100
Marker2 Low Period:	100
Marker2 Loop Number:	1
- Settings related to I/Q output
 

I/Q Output:	Fix Gain Path( $1V_{P-P}$ )
I/Q Offset:	0 mV
I/Q Output Filter:	Through
- Settings related to modulations
 

I/Q Input Source	Internal
I/Q ATT	Auto
- Settings output frequency
 

Frequency	5200 MHz
-----------	----------

### 4.3.3 Operation of RF Signal Output

- Settings output level  
Amplitude -10 dBm

[Required equipment]

R3681 series + Option 72

Conversion adapter: SMA (f)- SMA (f)

Conversion adapter: N (m)-BNC (f)

Output cable: BNC (m)-BNC (m)

#### Turning on the power supply

1. Verify that the power supply circuit breaker on the rear panel is OFF.
2. Connect the attached power cable to the AC power connector on the rear panel.
3. Turn ON the power supply circuit breaker on the rear panel.  
After turning ON the power supply circuit breaker, wait for three seconds or longer.
4. Turn ON the power switch on the front panel.  
When the self-test is completed, the screen returns to the startup screen.

---

**MEMO:** *The display after turning ON the power supply differs depending on the state of last use.*

---



## Initialization

Initializes the settings of this instrument.

5. Touch **[Special]** on the menu bar and select **[Preset]→[All]**.  
Initial setting conditions are loaded.

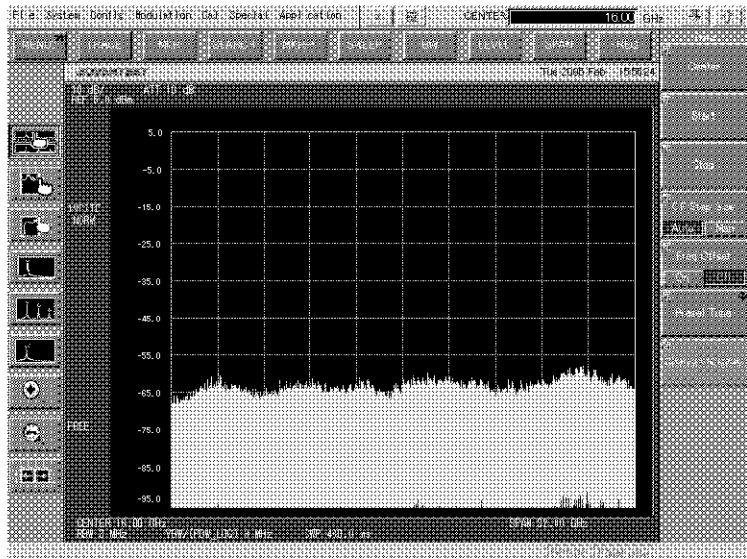

Figure 4-23 Initial Setting Screen

4.3.3 Operation of RF Signal Output

Connection

6. Attach the SMA(f)-SMA(f) adapter to the INPUT connector on the front panel. Attach the SMA(m)-BNC(f) adapter to the SMA(f)-SMA(f) adapter and connect the BNC(m)-BNC(m) cable to the SMA(m)-BNC(f) adapter and the SG output.

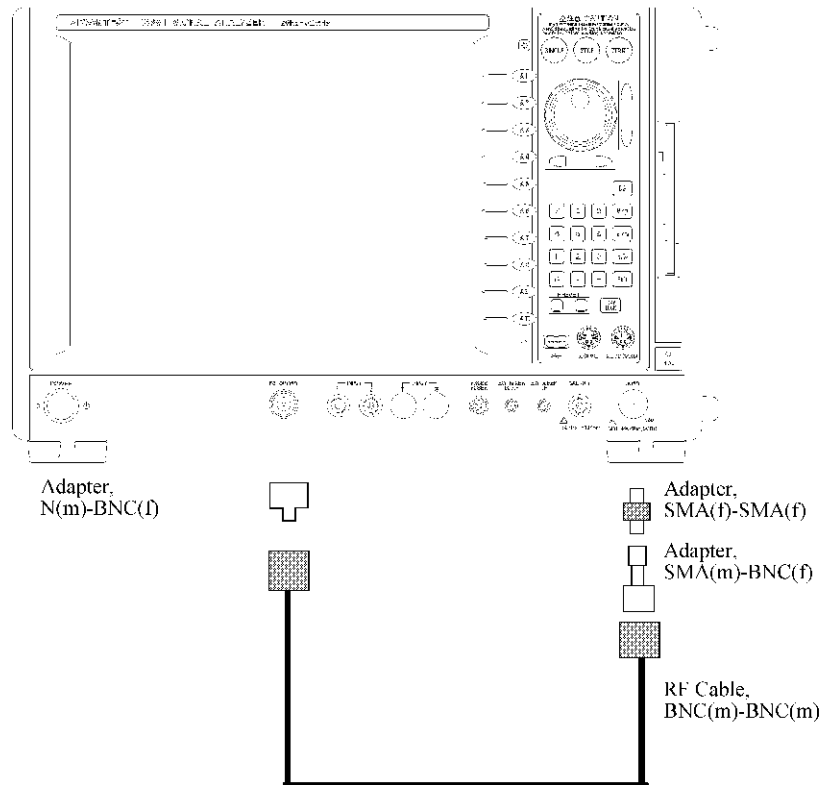

Figure 4-24 Connection diagram

AWG setting

7. Set the AWG to output the I/Q signals according to in steps 8 to 61 in "4.3.1 Operation from Waveform File Loading to I/Q Signal Output".

MOD setting

8. Touch the {MOD} button on the function bar.
9. Verify that the I/Q Input Source key on the soft menu bar has been set to Int.

If the key has been set to Ext, touch the I/Q Input Source key to set the key to Int.

10. Verify that the **I/Q ATT** key on the soft menu bar has been set to Auto.  
If the key has not been set to Auto, touch the **I/Q ATT** key to select **Auto**.  
Press the **Return** key to return the soft menu bar to the previous layer.
11. The modulation On state is set by pressing the active application button [**MOD ON**].

#### FREQ setting

12. Touch the **{FREQ}** button on the function bar.
13. Touch the **Frequency** key on the soft menu bar.  
Entry box is displayed and the output frequency can be input.
14. Press **5**, **2**, **0**, **0**, and **M/n**.  
The output frequency from the SG OUTPUT connector is set to 5200 MHz.

---

**NOTE:** Set the output frequency to 2.4 GHz in the R3671.

---

#### AMPL setting

15. Touch the **{AMPL}** button on the function bar.
16. Touch the **Amplitude** key on the soft menu bar.  
The entry box is displayed and the output level can be input.
17. Press **-**, **1**, **0**, and **ENT**.  
The output level from the SG OUTPUT connector is set to -10 dBm.
18. The output On state is set by pressing the active application button [**RF OUT ON**].

#### Checking the SG OUTPUT signal by using the SA

19. Touch the **{FREQ}** button on the function bar.
20. Press **5**, **2**, **0**, **0**, and **M/n**.

---

**NOTE:** Set the output frequency to 2.4 GHz in the R3671.

---

21. Touch the **{SPAN}** button on the function bar.

4.3.3 Operation of RF Signal Output

22. Press **2**, **0**, and **M/n**.

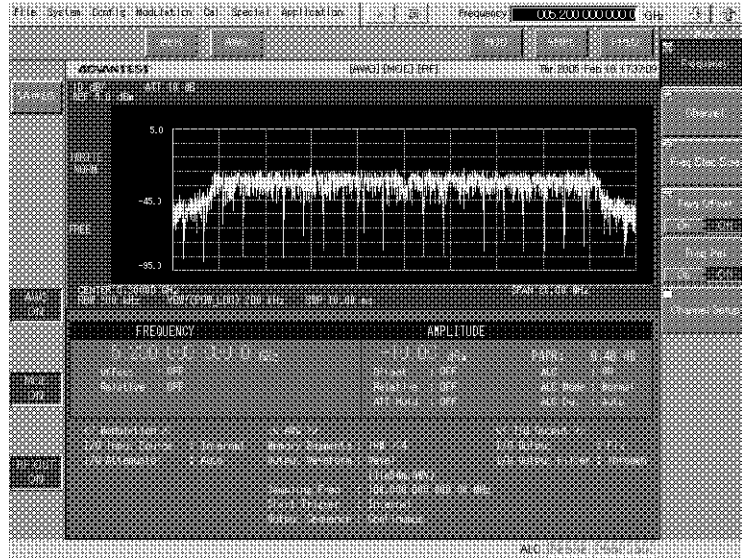



Figure 4-25 Example of Checking the SG OUTPUT Signal by Using the SA

## 5. MENU MAP, FUNCTIONAL EXPLANATION

This chapter describes the configuration and functions of the soft keys displayed on the touch screen of the SG+AWG option.

### MEMO:

1. [.....] *Used to enclose a menu name, key name, item name in the dialog box, button name, or the name of selected items in lists and menus.*
2. {....} *Shows a function button on the function bar.*
3.  *Shows a soft key on the soft menu bar.*
4. *A dialog box is surrounded by a broken line.*
5.  *Shows a text box for numeric input.*
6. *Operations are supposed to be made through a touch screen, and "touch" means to press a button or a key.*

### 5.1 Menu Index

Operation Key	Pages	Operation Key	Pages
[16M Word × 4] .....	5-9	[I/Q Output] .....	5-10, 5-18
[32M Word × 2] .....	5-9	[I/Q Output Filter] .....	5-10, 5-19
[64M Word × 1] .....	5-9	[I/Q Phase] .....	5-20
[Apply] .....	5-9, 5-17, 5-18	[I/Q value Interlock] .....	5-10, 5-18, 5-19
[Auto] .....	5-4	[Internal] .....	5-4, 5-9
[Auto Load] .....	5-9, 5-11	[Link] .....	5-9
[AWG Memory Mapping Information] ..	5-9, 5-10	[Load Data Size] .....	5-9, 5-12
[CH Start Freq] .....	5-25	[Load File] .....	5-9, 5-12
[CH Start No.] .....	5-25	[Load Waveform] .....	5-9, 5-10
[CH Step Freq] .....	5-25	[Loop Num] .....	5-14
[Clock Gate] .....	5-4, 5-6	[Loop Num 1] .....	5-9
[Clock Slope] .....	5-4, 5-6	[Loop Number] .....	5-17
[Continuous] .....	5-9, 5-14	[Loop Number 1] .....	5-9
[Data Polarity] .....	5-4, 5-5	[Low] .....	5-4
[External] .....	5-4	[Low Period] .....	5-17
[External Trigger Slope] .....	5-4, 5-7	[Low Period 1] .....	5-9
[Falling] .....	5-4	[Map Number] .....	5-9, 5-11
[Fix Gain Path(1V <sub>p-p</sub> )] .....	5-10, 5-18	[Marker] .....	5-9, 5-13
[Gated] .....	5-9, 5-15	[Marker 1(to SA)] .....	5-9, 5-16
[High] .....	5-4	[Marker 2(to Rear)] .....	5-9, 5-17
[High Period] .....	5-17	[Marker1] .....	5-9, 5-14
[High Period 1] .....	5-9	[Marker2] .....	5-9, 5-14
[I] .....	5-18, 5-19	[Memory] .....	5-9, 5-16
[I 0 mV] .....	5-10	[Memory Segments] .....	5-9, 5-10
[I 1000 mV <sub>p-p</sub> ] .....	5-10	[Mode] .....	5-9, 5-16
[I/Q Gain] .....	5-20	[Neg] .....	5-9
[I/Q Offset] .....	5-10, 5-19, 5-20	[Negative] .....	5-4, 5-9, 5-14

5.1 Menu Index

[OFF] .....	5-9, 5-10, 5-18	ATT Hold On/Off .....	5-22, 5-23
[Off] .....	5-4	Auto .....	5-20, 5-22, 5-24
[ON] .....	5-9	Auto Trimming .....	5-20, 5-21
[Output Sequence] .....	5-9, 5-14	AWG .....	5-3
[Output Waveform Select] .....	5-9, 5-13	BER .....	5-3
[Polarity] .....	5-9, 5-17	BER Display %/Exp .....	5-4, 5-8
[Pos] .....	5-9	Cal .....	5-3
[Positive] .....	5-4, 5-9, 5-14	Channel .....	5-25
[PRBS] .....	5-4, 5-5	Channel Setup .....	5-25
[Q] .....	5-18, 5-19	Config .....	5-3
[Q 0 mV] .....	5-10	CW .....	5-22, 5-24
[Q 1000 mV <sub>P-P</sub> ] .....	5-10	Cycle Count .....	5-4, 5-5
[Rising] .....	5-4	dBm .....	5-22, 5-23
[Sampling Freq] .....	5-13	dB $\mu$ V .....	5-22, 5-23
[Sampling Freq 200.0000000000 MHz] .....	5-9	dB $\mu$ Vemf .....	5-22, 5-23
[Select Wave] .....	5-9, 5-16	File .....	5-3
[Sequencer] .....	5-9, 5-16	FREQ .....	5-3
[Sequencer Setup] .....	5-9, 5-16	Freq Offset On/Off .....	5-25
[Single] .....	5-9, 5-14	Freq Rel On/Off .....	5-25
[Start Offset Period] .....	5-17	Freq Step Size .....	5-25
[Start Offset Period 0] .....	5-9	Frequency .....	5-25
[Start Trigger] .....	5-4, 5-7, 5-9, 5-14	Hold .....	5-22, 5-24
[Sync Mode] .....	5-4, 5-7	I/Q ATT .....	5-20
[Total Length] .....	5-9, 5-16	I/Q Input Source Int/Ext .....	5-20
[Trigger] .....	5-4	I/Q Output .....	5-9, 5-18
[Trigger Edge] .....	5-9, 5-15	I/Q Trimming .....	5-20
[Trigger Level] .....	5-9, 5-15	Load Data Size .....	5-9, 5-12
[Variable Gain Path] .....	5-10, 5-18	Marker Setup .....	5-9, 5-15
{AMPL} .....	5-22	Measure Bit Length .....	5-4
{AWG} .....	5-9	Measure Setup .....	5-4, 5-5
{BER} .....	5-4	MOD .....	5-3
{FREQ} .....	5-25	Modulation .....	5-3, 5-22, 5-24
{MOD} .....	5-20	Normal .....	5-22, 5-24
0 dB .....	5-20	Output Setup .....	5-9, 5-13
3 dB .....	5-20	Pass/Fail On/Off .....	5-4, 5-8
6 dB .....	5-20	Special .....	5-3
ALC Detector .....	5-22, 5-24	Stop on Error On/Off .....	5-4
ALC Hold Adj .....	5-22, 5-24	System .....	5-3
ALC Mode .....	5-22, 5-24	Waveform Setup .....	5-9, 5-10
ALC On/Off .....	5-22, 5-24		
AMPL .....	5-3		
Ampl Offset On/Off .....	5-22, 5-23		
Ampl Rel On/Off .....	5-22, 5-23		
Ampl Step Size .....	5-22, 5-23		
Ampl Units .....	5-22, 5-23		
Ampl Upper Limit .....	5-22, 5-23		
Amplitude .....	5-22, 5-23		
Application .....	5-3		

## 5.2 Switching SG+AWG

The menu bar of this option is arranged as follows:

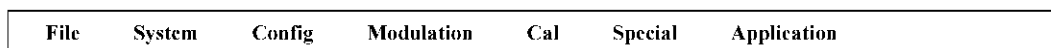

Select SG+AWG Option from Config on the menu bar to select the SG+AWG function.

## 5.3 Function Bar

This section describes the functions of each function button displayed on the function bar. The configuration of the function buttons of this option is as follows:



When you click a function button on the function bar, the associated soft keys are displayed on the soft menu bar.

## 5.4 Soft Menu Bar

The area located on the right-hand side of the screen and in which soft keys are displayed is called the soft menu bar.

When you touch a button on the function bar, the associated soft keys are displayed on the soft menu bar.

5.5 Description of the Function of Each Key

5.5 Description of the Function of Each Key

This section describes the function of each key.

5.5.1 {BER}

When you touch the {BER} button, the soft keys related to bit error rate measurement are displayed on the soft menu bar.

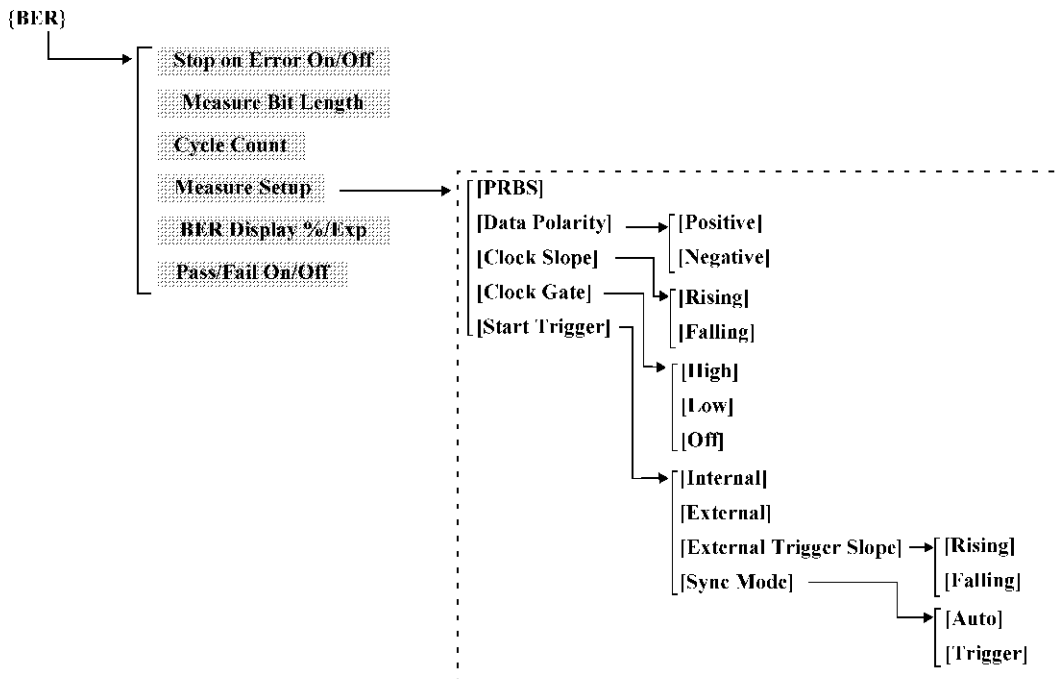

**Stop on Error On/Off**

Function to automatically stop bit error rate measurement if the judgment limit value set by the **Pass/Fail On/Off** button is exceeded.

On: Stop on error functions.

Off: Stop on error does not function.

---

**MEMO:** Measurement is stopped if the judgment limit value < bit error rate.

---

**Measure Bit Length**

Sets the measure bit length for bit error rate measurement.



**Cycle Count**

Sets the cycle count for the measure bit length.

---

**MEMO:** *Total number of bits of the measure bit length = Measure Bit Length × Cycle Count*

---

**Measure Setup**

If you touch **Measure Setup**, the setting dialog box necessary for carrying out BER measurement will be displayed.

**[PRBS]**

Selects the PRBS pattern for carrying out the measurement.

PN7: Selects PN7.

PN9: Selects PN9.

PN11: Selects PN11.

PN15: Selects PN15.

PN19: Selects PN19.

PN20: Selects PN20.

PN23: Selects PN23.

ALL0: Selects ALL0.

ALL1: Selects ALL1.

**[Data Polarity]**

Selects whether or not to reverse the polarity of the input data signal.

Positive: Does not reverse.

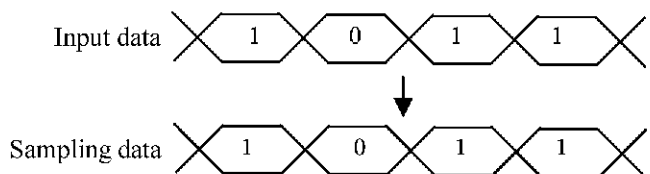

Negative: Reverses.

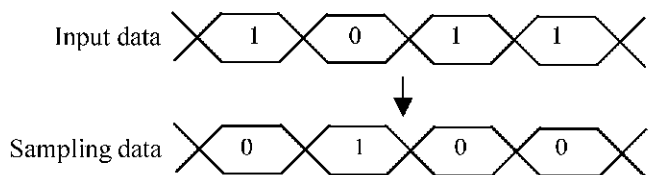

5.5.1 {BER}

**[Clock Slope]**

Selects whether sampling of the data will be carried out at the rising edge or the falling edge of the clock signal.

Rising: Sampling is carried out at the rising edge.

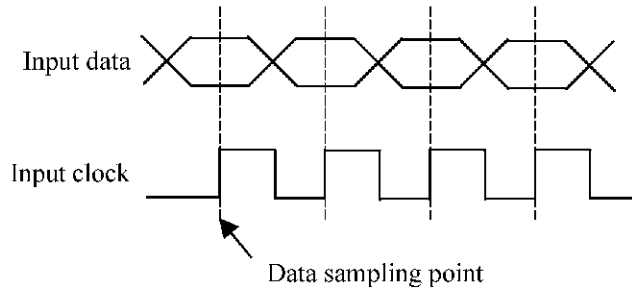

Falling: Sampling is carried out at the falling edge.

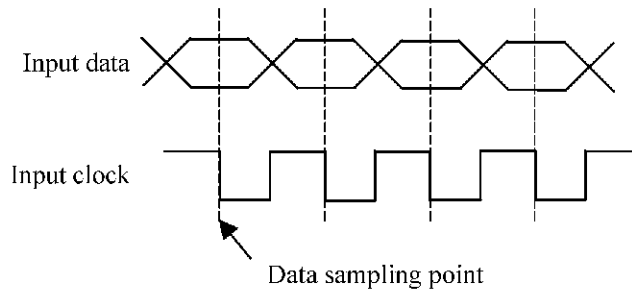

**[Clock Gate]**

Sampling of the data is carried out with the clock signal only for the section in which the clock gate signal is active.

High: Sampling of the data is carried out with the clock signal only for the section in which the clock gate signal is high.

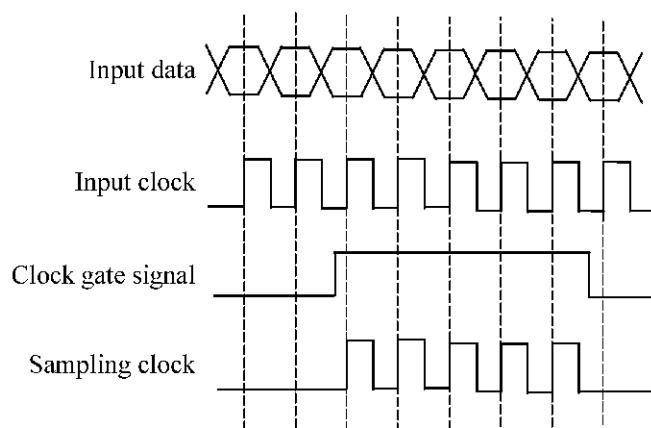

Low: Sampling of the data is carried out with the clock signal only for the section in which the clock gate signal is low.

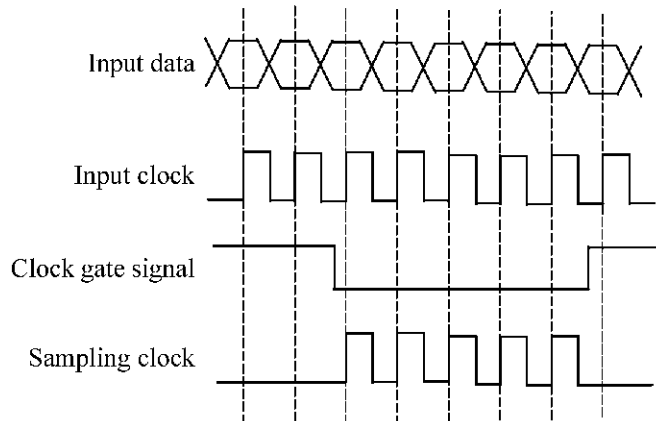

Off: Sampling of the data is carried out with the clock signal regardless of the clock gate signal.

#### [Start Trigger]

Selects the trigger signal to start the bit error rate measurement.

Internal: If you press the **START** key or **SINGLE** key on the front panel, the trigger signal is generated and measurement starts.

External: If you press the **SINGLE** key on the front panel, the system enters into the state of waiting for external trigger input. Measurement will be started at the moment at which the external trigger is input.

---

**MEMO:** For more information on setting of [Start Trigger], refer also to the [Sync Mode] function.

---

#### [External Trigger Slope]

Selects the polarity of the external trigger signal.

Rising: Takes the external trigger signal at the rising edge.

Falling: Takes the external trigger signal at the falling edge.

#### [Sync Mode]

Selects the synchronization mode of the bit error rate counter.

Auto: Automatically carries out synchronization for the PRBS group, ALL1 and ALL0.

Trigger: Carries out synchronization for the PRBS group, ALL1, and ALL0 according to the generated trigger signal.

5.5.1 {BER}

---

**IMPORTANT:** *When [Sync Mode] is set to trigger, synchronization is carried out according to the external trigger. If synchronization cannot be performed at that moment, measurement will be terminated.*

---

**BER Display %/Exp**

Changes the display of the result of BER measurement.

**%:** Changes the display of the result into percentage indication.

**Exp:** Changes the display of the result into exponential indication.

**Pass/Fail On/Off**

Displays Pass/Fail on the measurement result display screen.

**On:** If you touch the On button of **Pass/Fail On/Off**, the BER Limit setting entry box will be displayed. Input the bit error rate limit value in this entry box. If the result of the bit error rate measurement is within the bit error rate limit value input in the entry box, PASS will be displayed on the result display screen. If it exceeds it, FAIL will be displayed.

**Off:** Will not display PASS/FAIL.

5.5.2 {AWG}

If you touch the {AWG} key, the soft keys related to the AWG setting will be displayed on the soft menu bar.

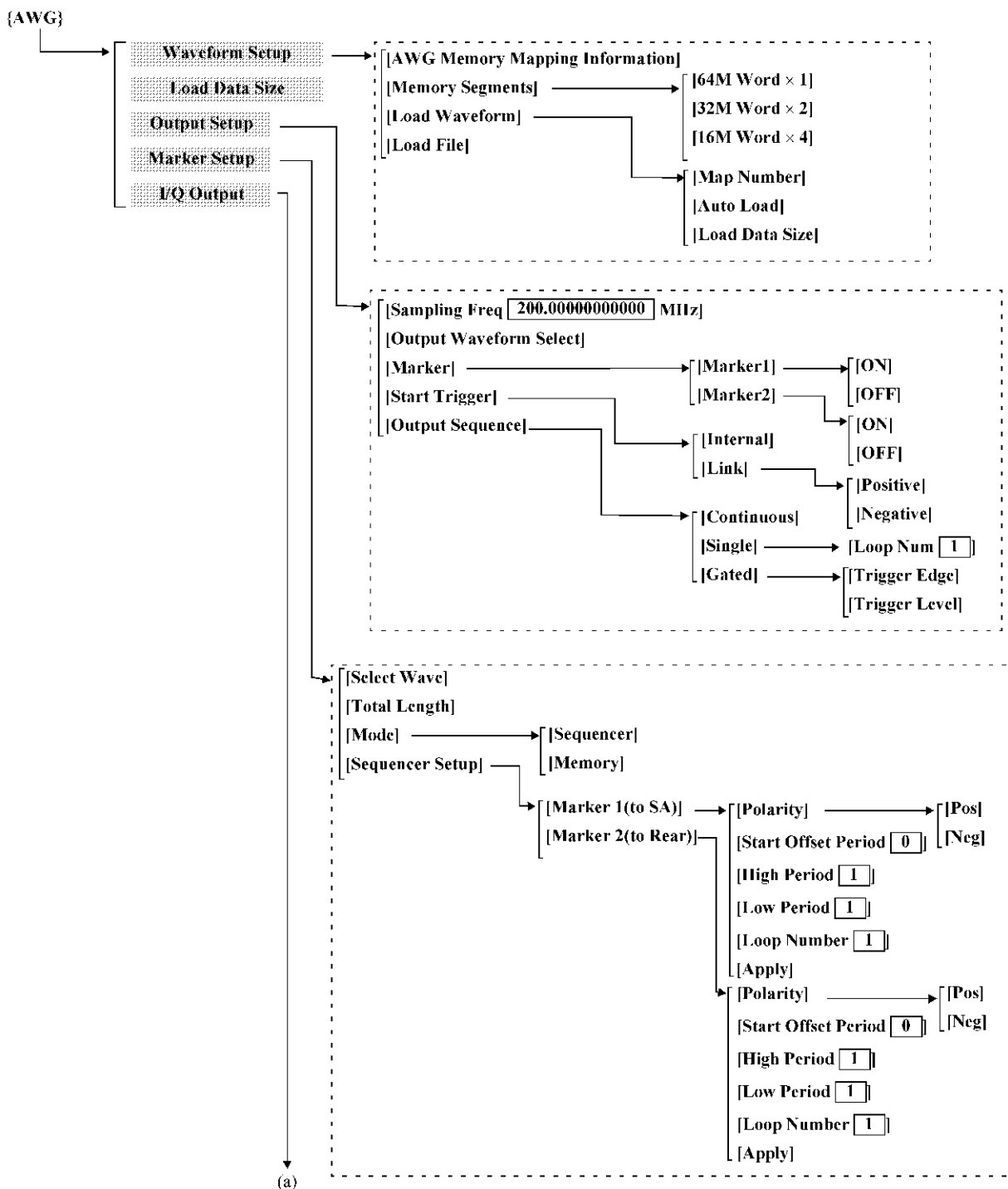

5.5.2 {AWG}

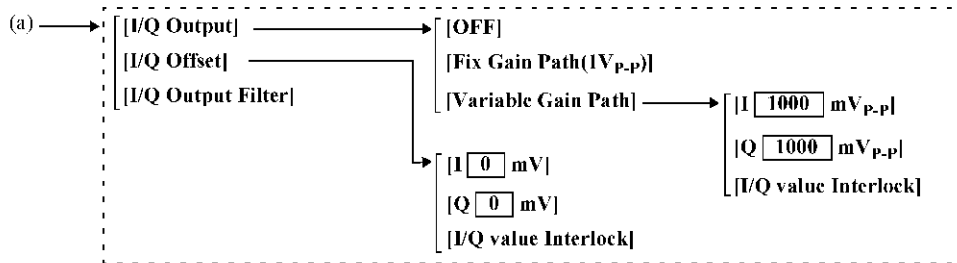

**Waveform Setup**

If you touch the **Waveform Setup** button, the setting dialog box related to data loading to the AWG will be displayed.

**[AWG Memory Mapping Information]**

Displays the data file name and data size (number of samplings) loaded on each memory segment.

**[Memory Segments]**

Sets with which of three split modes the waveform storage memory will be split.

64M Word × 1:

A mode in which only one waveform can be read in all the maps of 64M Word.

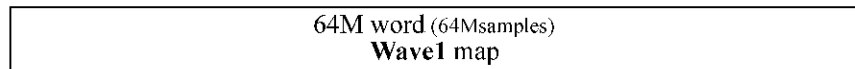

32M Word × 2 :

A mode in which the maps of 64M Word are divided into two equal parts and loaded in one waveform in any one of the 32M Word maps.

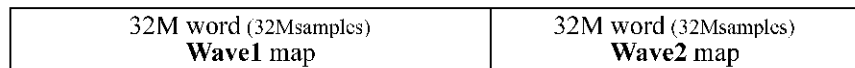

16M Word × 4:

A mode in which the maps of 64M Word are divided into four equal parts and loaded in one waveform in any one of the 16M Word maps.

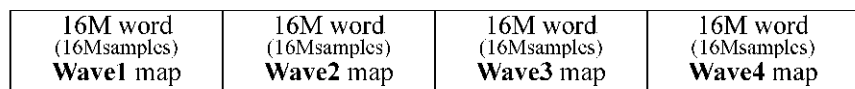

**IMPORTANT:** If the mode of [Memory Segments] is changed, all waveform data loaded on the memory will be erased.

**[Load Waveform]**

Performs setting necessary to load the waveform data.

**[Map Number]** Selects to which map among those determined by **[Memory Segments]** the waveform data will be loaded.

Wave1: Loads the waveform data on the Wave1 map.

Wave2: Loads the waveform data on the Wave2 map.

Wave3: Loads the waveform data on the Wave3 map.

Wave4: Loads the waveform data on the Wave4 map.

---

**CAUTION:** Fixed to Wave1 if the mode of **[Memory Segments]** is 64M Word  $\times$  1. Only Wave1 and Wave2 can be selected in the case of 32M Word  $\times$  2.

---

**[Auto Load]**

If **[Auto Load]** is checked, data on the waveform data file from the top address of the map specified by **[Map Number]** are transferred automatically to the waveform storage memory under the conditions in the following Examples.

If **[Auto Load]** is not checked, data are transferred, from the top address of an arbitrary map specified by **[Map Number]** and in the data size set to the **Load Data Size** on the soft menu bar, to the waveform storage memory.

Example 1: When the waveform storage memory of the map > the data size on the waveform data file.

**[Memory Segments]**  $\rightarrow$  16M Word  $\times$  4

**[Map Select]**  $\rightarrow$  Wave2

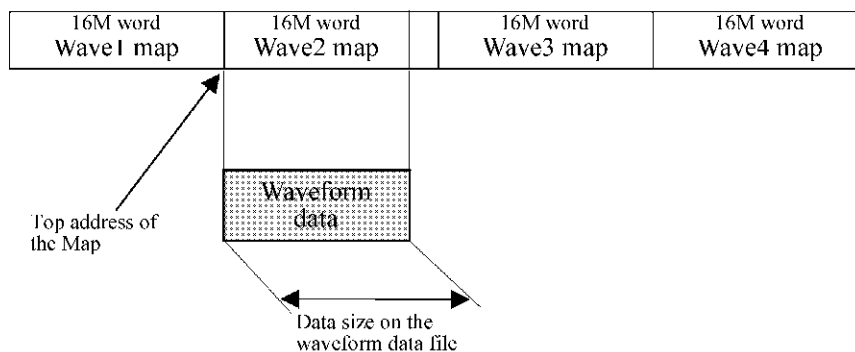

5.5.2 {AWG}

Example 2: When the waveform storage memory of the map < the data size on the waveform data file.

[Memory Segments]→16M Word × 4

[Map Select]→Wave2

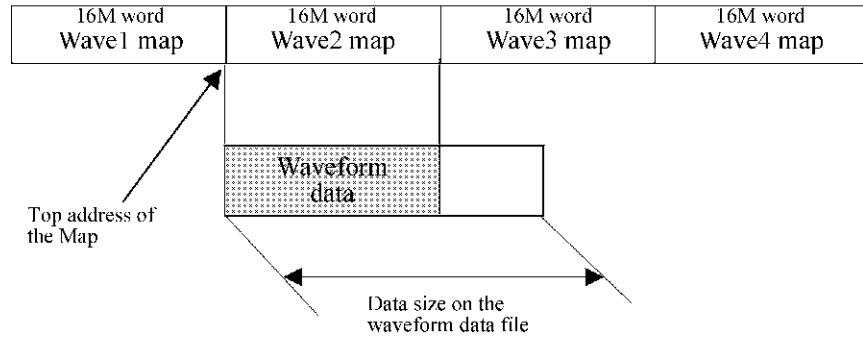

**MEMO:** Refer also to the **Load Data Size** button on the soft menu bar.

[Load Data Size]

Displays in a hexadecimal number the data size (number of samplings) to be loaded from the waveform data file to any map specified by [Map Number] of the waveform storage memory.

[Load File]

Loads the waveform data from the waveform data file to any map specified by [Map Number] of the waveform storage memory.

**Load Data Size**

Inputs as a hexadecimal number the data size (number of samplings) to be loaded from the waveform data file to any map specified by [Map Number] on the waveform storage memory in the state in which the [Auto Load] check box on the dialog box displayed if the **Waveform Setup** button is touched is not checked (when manually loaded).

**CAUTION:** If the [Auto Load] function is checked, the value input by [Load Data Size] will not be reflected.

**IMPORTANT:** The minimum values for the data size are 1024 samples (0x400).  
The value for a data size must be a multiple of 4.  
If the number is not a multiple of four, normal waveforms cannot be obtained in this AWG.



**Output Setup**

If you touch the **Output Setup** button, the setting dialog box related to the AWG output will be displayed.  
The AWG functional block diagram is shown below.

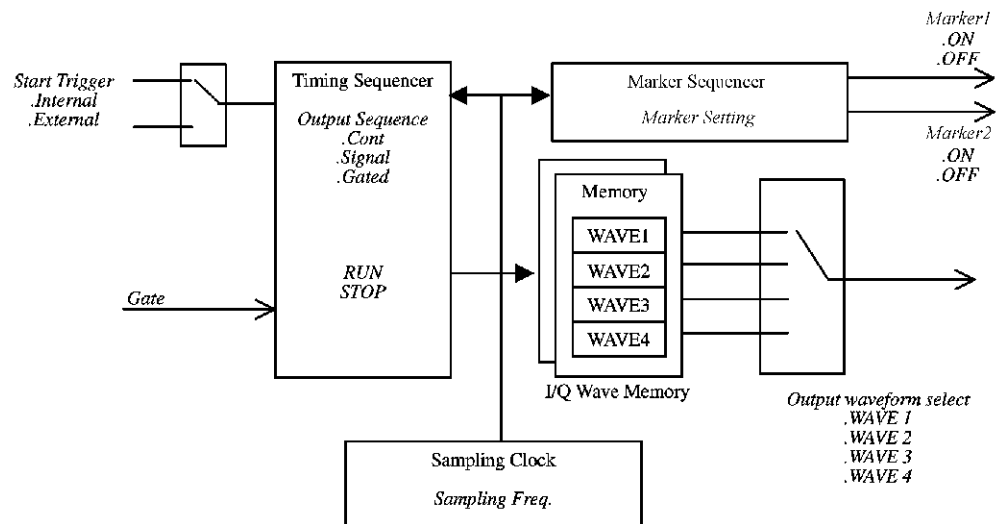
**[Sampling Freq]**

Sets the sampling frequency.

**CAUTION:** If the ratio between the output signal frequency and the sampling frequency (the number of over-sampling) is small, crossed spurious signals may generate.

**Formula**

$$\Delta f = \left| m \times 10 \text{MHz} - n \times \frac{\text{Sampling frequency}}{2} \right|$$

$\Delta f$ : Frequency from the carrier  $m$  and  $n$  are integers.

**Example**

Output frequency: 49.995 MHz

Sampling Frequency: 199.98 MHz

The number of over-sampling: 4

$$\Delta f = 10 \text{kHz} \quad m = 10, n = 1 < -55 \text{dBc}$$

**[Output Waveform Select]**

Of the maps set by [Memory Segments], selects which map's data will be output.

**CAUTION:** Fixed to Wave1 if the mode of [Memory Segments] is 64M Word  $\times$  1. Only Wave1 and Wave2 can be selected in the case of 32M Word  $\times$  2.

**[Marker]**

Performs setting for the marker output.

5.5.2 {AWG}

<b>[Marker1]</b>	<p>Performs output setting for marker 1.</p> <p>ON: Outputs the marker signal.</p> <p>OFF: Stops the marker signal output.</p>
<b>[Marker2]</b>	<p>Performs output setting for marker 2.</p> <p>ON: Outputs the marker signal.</p> <p>OFF: Stops the marker signal output.</p>
<b>[Start Trigger]</b>	<p>Performs setting of the AWG start trigger.</p> <p>Internal: The trigger signal is generated by pressing the <b>[AWG ON]</b> button below the active application button and the AWG starts generating the waveform.</p> <p>Link: The AWG entered the status, where it waits for the trigger signal to be input from SA, by pressing the <b>[AWG ON]</b> button below the active application button. If the trigger signal is input from SA, the AWG starts generating the waveform.</p>

*MEMO: As types of triggers for SA, Free Run, IF Power, Video, EXT1, EXT2 and Line are available. For more information, refer to the R3681 Series User's Guide.*

<b>[Positive]</b>	Starts at the rising edge of the trigger input from the SA.
<b>[Negative]</b>	Starts at the falling edge of the trigger input from the SA.
<b>[Output Sequence]</b>	Sets the AWG waveform generation sequence.
<b>[Continuous]</b>	Outputs waveform data continuously.

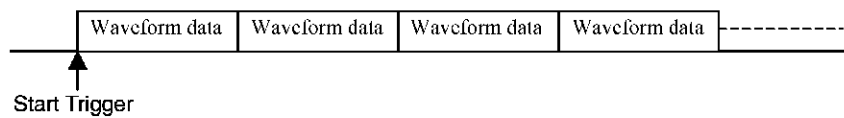

**[Single]** When the start trigger is input, waveform data are output the number of times set by the loop number and then output terminates.

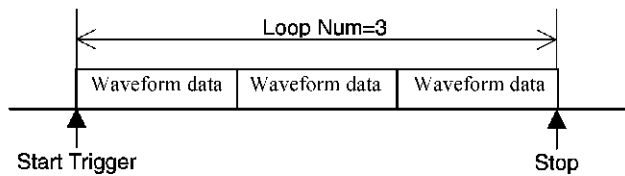

**[Loop Num]** Sets the number of times of repetition when the waveform generation sequence is set to **[Single]**.

**[Gated]** Controls the waveform data output sequence with the trigger signal input from the SA.

**[Trigger Edge]** Controls the waveform output with the edge of the trigger signal input from the SA.

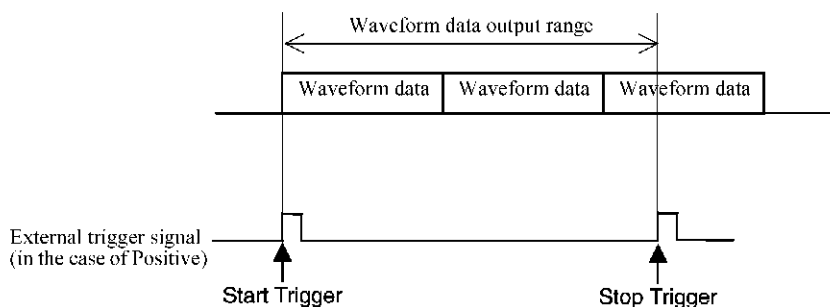

**[Trigger Level]** Controls the waveform data output with high and low level input from the SA.

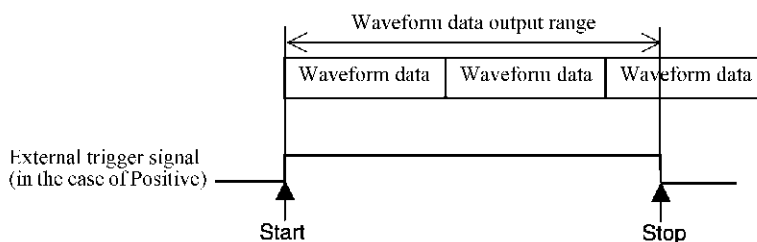

---

**CAUTION:**

1. If the Link is set to [Positive], the waveform signal is output at high level.  
If the Link is set to [Negative], the waveform signal is output at low level.
  2. The [Gated] function of [Output Sequence] becomes active when [Start Trigger] is set to Link.
- 

**Marker Setup**

If you touch the **Marker Setup** button, the setting dialog box related to AWG marker output will be displayed.

This function is to output the trigger signal synchronized to the waveform data and used for synchronized measurement with the SA or to synchronize to external devices.

There are two groups of markers and marker 1 is internally connected with the trigger input of the SA directly.

With marker 2, the signal is output to the back panel. Each marker can be set independently.



**[Polarity]** Sets the polarity of marker 1.

Pos: Does not reverse.

Neg: Reverses.

Marker signal when setting Pos

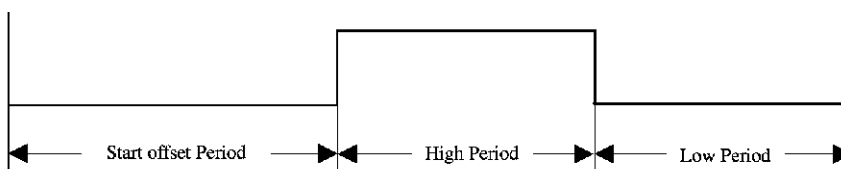

Marker signal when setting Neg

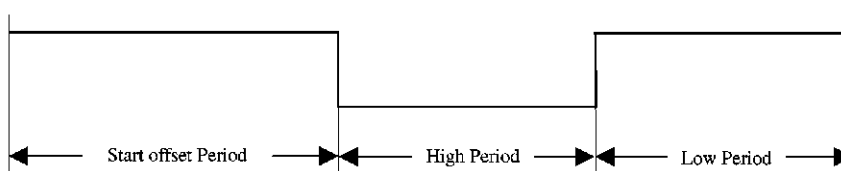

**[Start Offset Period]**

Inputs the start offset time by using number of sampling points.

**[High Period]** Inputs the time of the high period by using number of sampling points.

**[Low Period]** Inputs the time of the low period by using number of sampling points.

**[Loop Number]** Inputs the number of repetitions between the high period and the low period.

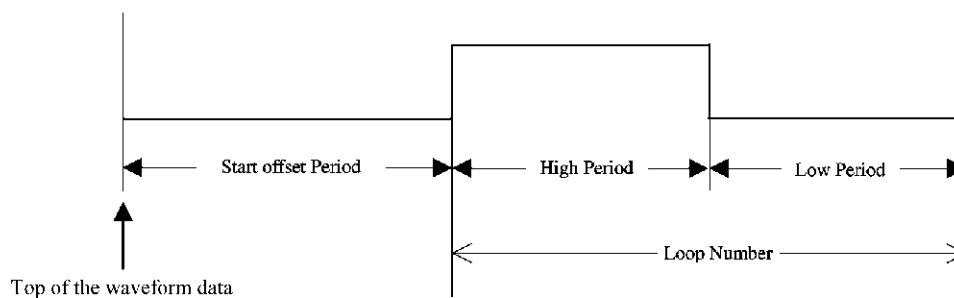

**[Apply]** Reflects the setting for marker 1.

**[Marker 2(to Rear)]**

Performs the setup for the sequencer marker of marker 2.

**[Polarity]** The same description as that for marker 1 applies.

**[Start Offset Period]**

The same description as that for marker 1 applies.

**[High Period]** The same description as that for marker 1 applies.

**[Low Period]** The same description as that for marker 1 applies.

**[Loop Number]** The same description as that for marker 1 applies.

5.5.2 {AWG}

[Apply] Reflects the setting for marker 2.

**I/Q Output**

If you touch the **I/Q Output** button, the setting dialog box related to the I/Q output of the AWG will be displayed.

[I/Q Output]

Sets the output level of the I/Q.

[OFF]

Turns OFF the I/Q output.

[Fix Gain Path(1V<sub>p-p</sub>)]

A mode in which the maximum amplitude of the I/Q output becomes 1 V<sub>p-p</sub>

[Variable Gain Path]

A mode in which the maximum amplitude of the I/Q output is variable.

[I]

Sets the output level amplitude of the I channel when setting the variable gain path mode.

[Q]

Sets the output level amplitude of the Q channel when setting the variable gain path mode.

[I/Q value Interlock]

If the check box is checked, the settings for the output level amplitude of the I/Q vary by the same value.  
If not checked, the setting of the output level amplitude can be made independently for I and Q.

Waveform data (DAC data)

I/Q output

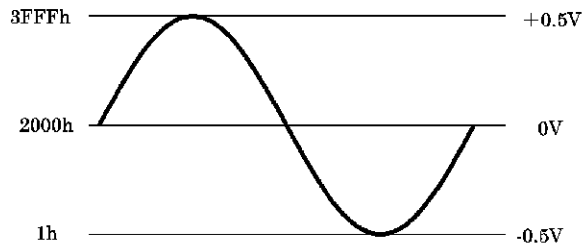

Relationship between the waveform data and I/Q output voltage (for Fix Gain Path)

Waveform data (DAC data)

I/Q output

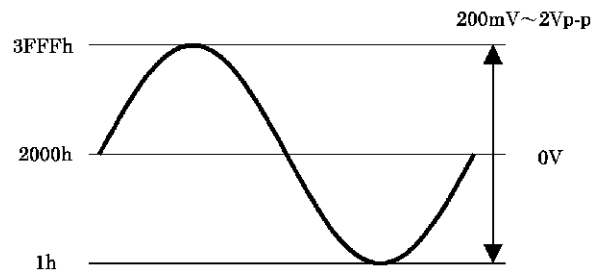

Relationship between the waveform data and I/Q output voltage (for Variable Gain Path)

---

<b>[I/Q Offset]</b>	Sets the DC offset to the output level of the I/Q.
<b>[I]</b>	Sets the DC offset of the I channel.
<b>[Q]</b>	Sets the DC offset of the Q channel.
<b>[I/Q value Interlock]</b>	If the check box is checked, the settings for the DC offset of the I/Q vary by the same value. If not checked, the setting of the DC offset can be made independently for I and Q.
<b>[I/Q Output Filter]</b>	Selects the base band filter. 2.5MHz: Selects the 2.5 MHz filter. 50MHz: Selects the 50 MHz filter. Through: Selects Through.

5.5.3 {MOD}

5.5.3 {MOD}

If the {MOD} button is touched, the soft keys, which relate to the modulation setting, are displayed on the soft menu bar.

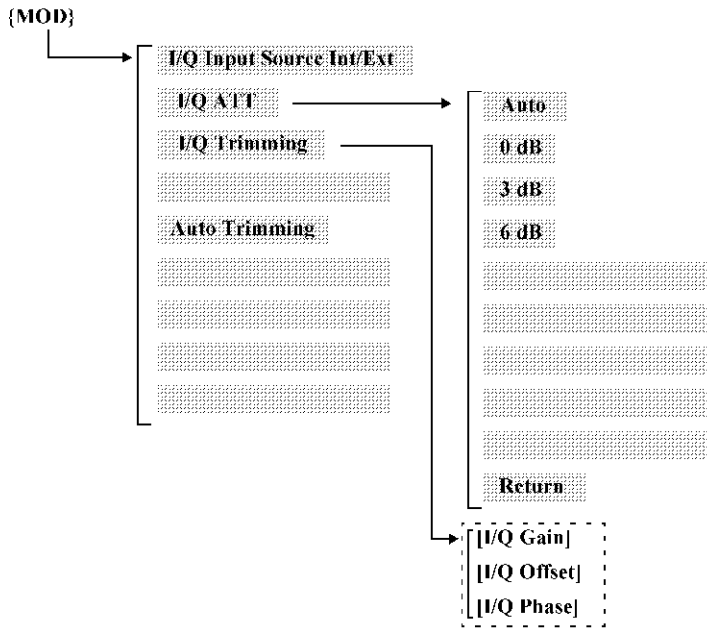

**I/Q Input Source Int/Ext**

Switches the signal which modulates.

Internal: The output signal is modulated by the I/Q signal of the internal AWG.

External: The output signal is modulated by the external I/Q signal.

**I/Q ATT**

Displays the menu for selecting the attenuation which is internally inserted along the I/Q signal path.

**Auto**

Selects the attenuation automatically.

**0 dB**

Selects the 0 dB attenuation.

**3 dB**

Selects the 3 dB attenuation.

**6 dB**

Selects the 6 dB attenuation.

**Return**

Returns to the previous layer menu.

**I/Q Trimming**

Displays the dialog box for adjusting the I/Q signals.

**[I/Q Gain]**

Changes the I/Q signal gain.

**[I/Q Offset]**

Changes the I/Q signal DC offset.

**[I/Q Phase]**

Changes the I/Q signal phase.



**Auto Trimming**

Automatically adjusts the I/Q DC offset and minimizes the carrier leak of the modulation signal.

**IMPORTANT:** *SG OUTPUT must be connected to INPUT before performing Auto Trimming because SA measures the SG output signal and then IQ Trimming is performed.*

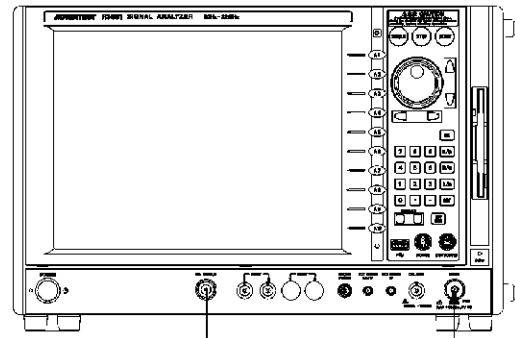

Connect when performing Auto Trimming.

5.5.4 {AMPL}

5.5.4 {AMPL}

If the {AMPL} button is touched, the soft keys, which relate to the RF signal output level setting, are displayed on the soft menu bar.

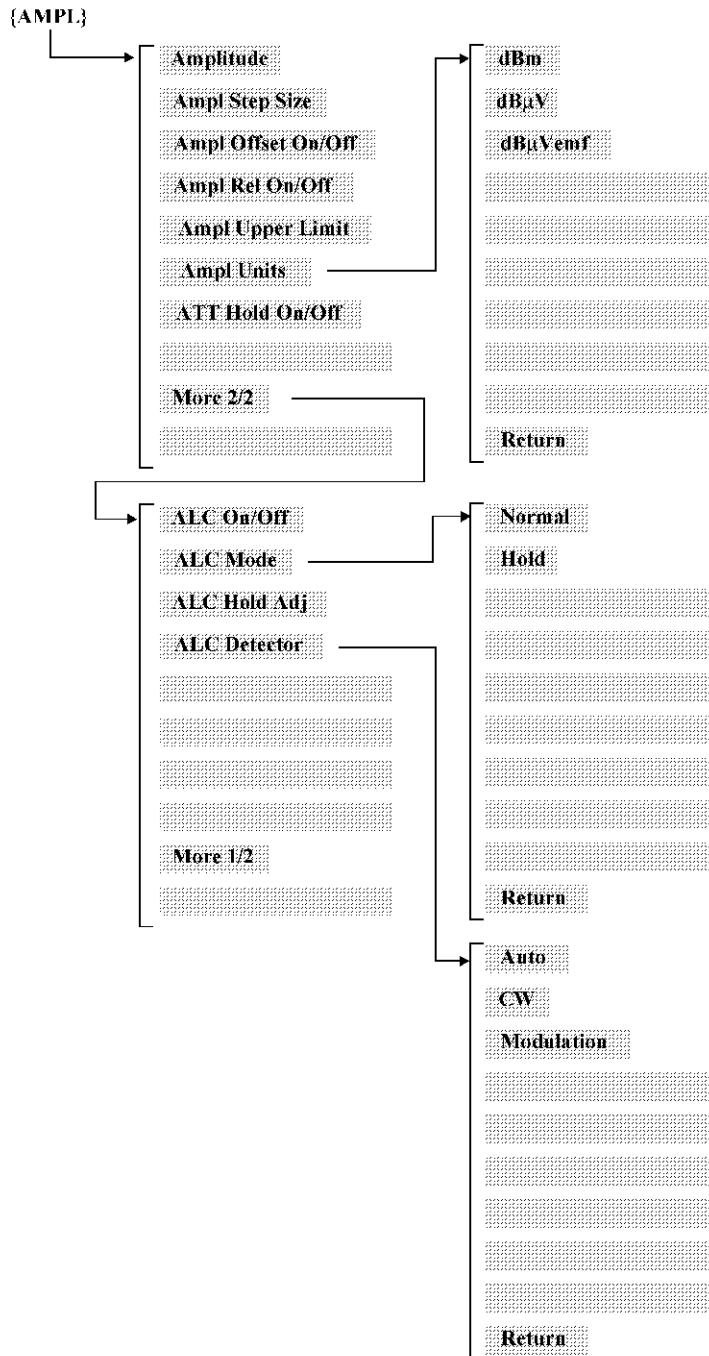

**Amplitude**

Activates the RF signal output level setting.

---

**CAUTION:** *UNLEVEL is displayed in the outside of the range in which the level accuracy can be guaranteed.*

---

**Ampl Step Size**

Sets the level which can be increased or decreased by pressing the step key ( $\Delta$  /  $\nabla$ ).

Although the digit selected by the digit key ( $\triangleleft$  /  $\triangleright$ ) is usually increased or decreased  $\pm 1$  by pressing the step key, the set level can also be increased or decreased according to the step size by pressing the step key if **Ampl Step Size** is set.

**Ampl Offset On/Off**

Switches On and Off the offset display of the output level.

On: Sets the offset value and changes only the display of the output level by the offset value.

Off: Cancels the offset function.

**Ampl Rel On/Off**

Switches On and Off the relative display of the output level.

On: The current set output level is displayed as 0 dB and the level variation from the current set level is displayed relative to that.

Off: Cancels the relative display function.

**Ampl Upper Limit**

Specifies the upper limit value of the output level at the RF OUT connector. The level, which exceeds the specified level, cannot be set.

**Ampl Units**

Displays the Units menu.

**dBm**

Sets the display unit to dBm.

**dB $\mu$ V**

Sets the display unit to dB $\mu$ V.

**dB $\mu$ Vemf**

Sets the display unit to dB $\mu$ Vemf.

**Return**

Returns to the previous layer menu.

**ATT Hold On/Off**

Switches On and Off the fixed mode of the attenuator value.

On: Fixes the attenuator to the current value. The output level can be changed continuously by using the ALC variable.

Off: Cancels the fixed mode of the attenuator value.

---

**MEMO:** *If the output level is set to the outside of the allowable range, this mode cannot be set to On.*

---

**More 2/2**

Displays the Ampl menu (2/2).

5.5.4 {AMPL}

**ALC On/Off**

Switches On and Off the ALC operation.

On: Sets the level control loop of the RF signal to On.

Off: Sets the level control loop of the RF signal to Off. In the Off setting, the level is maximized in the ALC controlled range.

---

**NOTE:** *UNLEVEL is displayed when ALC is set to Off.*

---

**ALC Mode**

Displays the menu for selecting the ALC mode of the RF signal.

**Normal**

Sets ALC to the Normal mode.

**Hold**

Sets ALC to the Hold mode.

**Return**

Returns to the previous layer menu.

**ALC Hold Adj**

Readjust the ALC hold voltage.

**ALC Detector**

Displays the menu for selecting the ALC detector.

**Auto**

Sets the ALC detector automatically.

**CW**

Sets the ALC detector to the non-modulation mode.

**Modulation**

Sets the ALC detector to the modulation mode.

**Return**

Returns to the previous layer menu.

**More 1/2**

Displays the Ampl menu (1/2).

### 5.5.5 {FREQ}

If the {FREQ} button is touched, the soft keys, which relate to the RF signal output frequency setting, are displayed on the soft menu bar.

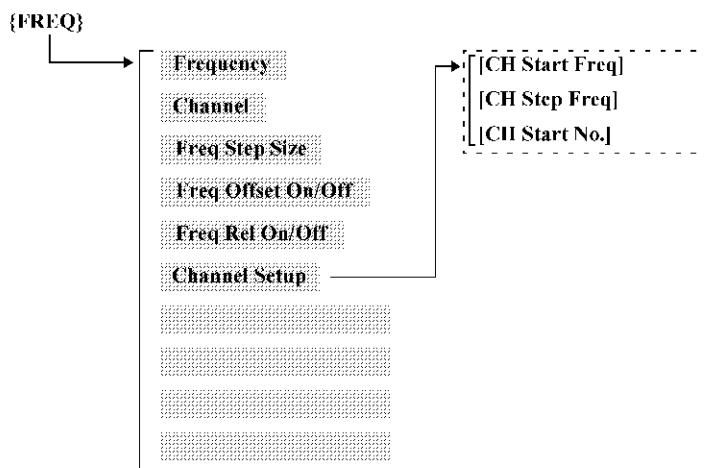

#### Frequency

Activates the RF signal output frequency setting.

#### Channel

Activates the output frequency channel number setting of the RF signal.

#### Freq Step Size

Sets the frequency which can be increased or decreased by pressing the step key ( $\Delta$  /  $\nabla$ ).

Although the digit selected by the digit key ( $\langle$  /  $\rangle$ ) is usually increased or decreased  $\pm 1$  by pressing the step key, the set frequency can also be increased or decreased according to the step size by pressing the step key if Freq Step Size is set.

#### Freq Offset On/Off

Switches On and Off the frequency offset display of the output.

On: Sets the offset value and changes only the display of the output frequency by the offset value.

Off: Cancels the offset function.

#### Freq Rel On/Off

Switches On and Off the relative display of the output frequency.

On: The current set output frequency is displayed as 0 Hz and the frequency variation from the current set frequency is displayed relative to that.

Off: Cancels the relative display function.

#### Channel Setup

Display the setting dialog box of the output frequency channel.

[CH Start Freq]

Sets the channel start frequency.

[CH Step Freq]

Sets the channel step frequency.

[CH Start No.]

Sets the channel start number.

5.5.5 {FREQ}

---

*MEMO: Output frequency = Channel start frequency + Channel step frequency \* (Channel number - Channel start number)*





---

## 5.6 Tool Menu

This section describes the tool menu.

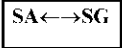
Functions of the tool menu are activated by touch screen operation.

The following functions are allocated to the tool menu.

- |   |   |
|---|---|
|  | Sets the function bar and soft menu bar to either the SA mode or the SG(SG+AWG) mode. |
|  | Switches ON and OFF the AWG.  |
|  | Switches ON and OFF the modulation function.  |
|  | Switches ON and OFF the RF signal output.   |





## 6. SCPI COMMAND REFERENCE

This chapter describes the command reference of this instrument.

---

**MEMO:** *For an outline of the remote control, basic measurement procedures, etc., refer to the attached manual "Programming Guide."*

---

### 6.1 Command Reference Format

This section describes the format of explanations of each command described in this chapter.

Explanations of each command include the following items:

- Function
- Command
- Parameter
- Query

- [Command]

The command shows the syntax of a command sent from the external controller to this instrument. The syntax consists of a command part and a parameter part. The command part and parameter part are delimited by a space.

When there are multiple parameters, they are delimited by commas (,). The three points (...) displayed between commas represent the parameter(s) omitted in the position.

For example, the description <numeric value 1>, ..., <numeric value 4> shows that four parameters, <numeric value 1>, <numeric value 2>, <numeric value 3>, and <numeric value 4>, are required.

When the parameter is a character string type such as <character string>, <character string I>, the parameter must be enclosed in double quotation marks (" "). When the parameter is <block>, it shows the block format data.

The part written in lowercase alphabetical characters in the syntax shows that it can be omitted.

For example, ":CALibration:CABLe" can be abbreviated to ":CAL:CABL".

The marks used in the syntax are defined as follows:

<>:	Shows a parameter required for sending a command.
[ ]:	Shows that the command is optional. It can be omitted.
{ }:	Shows that only one item is required to be selected from multiple items.
:	Written in curly brackets {..} and used as a delimiter for multiple items.
<ch>:	Written in the command header and shows the target input channel number of the command. The channel number can be omitted. However, when it is written, the channel number 1 is selected.
<bch>:	Written in the command header and indicates the BER measurement target channel of the command. The BER measurement channel number can be omitted. However, when it is written, channel number 1 is selected.

6.1 Command Reference Format

- <mk>: Written in the command header and indicates the target marker of the command. The marker number can be omitted. However, when it is written, a value from 1 to 2 is selected.  
[ { 1|2 } ]
- <mno>: Written in the command header and indicates the Waveform Memory number that is the target of the command. The Waveform Memory number can be omitted. However, when it is written, a value from 1 to 4 is selected.  
[ { 1|2|3|4 } ]

- [Function]

Indicates the outline of the action of this instrument when the command is executed.

- [Parameter]

Describes a parameter required for sending a command.

When the parameter is a numeric type or a character (string) type, it is enclosed in angle brackets (<>).

When the parameter is an optional type, it is enclosed in curly brackets { }.

In this manual, parameter types are described in the following formats:

- < int >: A numeric value that can be input in the format NR1, NR2, or NR3 and rounded to an integer in this instrument
- < real >: A numeric value that can be input in the format NR1, NR2, or NR3 and rounded to a valid-digit real number in this instrument
- < bool >: String of OFF|ON
- < str >: A character string or alphanumeric symbols enclosed in quotation ( ' ') or double quotation ( " ") marks
- < block >: Block data type  
The content of data is an 8-bit binary data array
- < type >: Character data selected from multiple types

- [Query]

When there is a query reply to the command, the data format used for reading the query is described.

Each parameter to be read is enclosed in curly brackets { }. When multiple items delimited by a vertical bar (|) exist in curly brackets { }, only one of those items is read out. When multiple parameters are read out, they are delimited by commas (.). The three points (...) displayed between commas represent the data omitted in the position. For example, the description <numeric value 1>, ..., <numeric value 4> shows that four parameters <numeric value 1>, <numeric value 2>, <numeric value 3>, and <numeric value 4> are read.

When the parameter to be read is enclosed in square brackets [ ], the parameter may be omitted, depending on the measurement result, etc.

For each read-out parameter, a unit such as "dBm" is displayed in the column for the unit, to show the unit for the parameter value. However, only when the parameter is described in a level unit "dBm," the level unit selected at that time will be applied to the parameter.

## 6.2 Common Commands

Function	Command	Parameter	Query	Remarks
Clears the status byte and related data	*CLS	---	---	
Macro definition for GET	*DDT	<block>	<block>	*1
Sets the standard event status enable register	*ESE	<int>	<int>	
Reads the standard event status register	*ESR?	---	<int>	
Device inquiry	*IDN?	---	<str>	*2
Notice of completion of running operations	*OPC	---	1	
Recalls device settings	*RCL	<int>	---	
Resets the device	*RST	---	---	
Saves the device settings	*SAV	<int>	<int>	
Sets the service request enable register	*SRE	<int>	<int>	
Reads the status byte register	*STB?	---	<int>	
Self-test execution and inquiry for the results	*TST?	---	<int>	
Waits for the completion of all running operations	*WAI	---	---	

\*1: If the \*DDT? command is executed when the macro is undefined, zero-length block data (#10) is returned.

\*2: <str> is output in the format of "maker name, model name, serial number, version number."

6.3 BER Button

6.3 BER Button

Function	Command	Parameter	Query	Unit	Remarks
BER measurement condition setting					
Stop on Error	:CALCulate<ch> :BERT<bch>:COMParator:MODE	{CEND  FHOLd}	{CEND  FHOL}	--	
Setting measure bit length	:SENSe<ch>:BERT<bch>:TBITs	<int>	<int>	--	
Setting the measurement cycle	:SENSe<ch> :BERT<bch>:TRIGger:COUNt	<int>	<int>	--	
Setting PRBS pattern	:SENSe<ch> :BERT<bch>:PRBS[:DATA]	{PN7 PN9  PN11 PN15  PN19 PN20  PN23 ALL_ 0 ALL_1}	{PN7 PN9  PN11 PN15  PN19 PN20  PN23 ALL_ 0 ALL_1}	--	
Data polarity POSI/NEGA	:INPut<ch> :BERT<bch>:DATA:POLarity	{POSitive  NEGative}	{POS NEG}	--	
Clock Slope RISE/FALL	:INPut<ch> :BERT<bch>:CLOCK:POLarity	{POSitive  NEGative}	{POS NEG}	--	
Clock Gate HIGH/LOW/OFF	:INPut<ch> :BERT<bch>:CGATE:POLarity	{HIGH  LOW OFF}	{HIGH  LOW OFF}	--	
Start Trigger selection INT/EXT	:SENSe<ch> :BERT<bch>:TRIGger[:SOURce]	{INTernal  EXTernal}	{INT EXT}	--	
Ext Trigger Slope RISE/FALL	:SENSe<ch> :BERT<bch>:TRIGger:POLarity	{POSitive  NEGative}	{POS NEG}	--	
SYNC mode AUTO/TRIG	:SENSe<ch> :BERT<bch>:RSYNc[:STATe]	{ON OFF}	{ON OFF}	--	
BER indicated unit %/EXP	:CALCulate<ch> :BERT<bch>:DISPlay:MODE	{PERCent  SCientific}	{PERC SCI}	--	
PASS/FAIL judgment ON/OFF	:CALCulate<ch> :BERT<bch>:COMParator[:STATe]	{ON OFF}	{ON OFF}	--	
Setting the BER Limit	:CALCulate<ch> :BERT<bch> :COMParator:THReshold	<real>	<real>	--	* 1

Function	Command	Parameter	Query	Unit	Remarks
Loading BER measurement result					
Loading Bit Error Rate	:CALCulate<ch> :BERT<bch>:DATA:BER?	---	<real>	--	*1
Loading Error Bits	:CALCulate<ch> :BERT<bch>:DATA:TBEC?	---	<str>	--	
Loading Total Bits	:CALCulate<ch> :BERT<bch>:DATA:TBIT?	---	<str>	--	
Loading Cycle Count	:CALCulate<ch> :BERT<bch>:DATA:CYCL?	---	<int>	--	
Loading Pass/Fail	:CALCulate<ch> :BERT<bch>:DATA:JUDGE?	---	{PASS  FAIL}	--	

\*1: The unit will be the unit selected with the BER display unit (% or EXP).

6.4 AWG Button

6.4 AWG Button

Function	Command	Parameter	Query	Unit	Remarks
<b>Waveform Setup</b>					
Memory segment setting	[ :SOURce<ch>] :SG:WFMSegment:TYPE	{S64M  S32M  S16M}	{S64M  S32M  S16M}	--	*1
Data size (Sampling count) setting	[ :SOURce<ch>] :SG:WFM<mno>:LENGth	<hex>	<hex>	--	*2
Loading mode AUTO/MAN	[ :SOURce<ch>] :SG:WFM<mno>:LOAD:AUTO	{ON OFF}	{ON OFF}	--	*3
Load execution	[ :SOURce<ch>] :SG:WFM<mno>:LOAD	<str>	<str>	--	*4
<b>Output Setup</b>					
Setting sampling frequency	[ :SOURce<ch>]:SG:CLOCK:STATe	<real>	<real>	Hz	
Start trigger selection INT/LINK	[ :SOURce<ch>]:SG:TRIGger:SOURce	{INTernal  LINK}	{INT  LINK}	--	
External trigger polarity POS/NEGA	[ :SOURce<I 2>] :SG:TRIGger:EXTernal:POLarity	{POSitive  NEGative}	{POS NEG}	--	
Internal trigger mode CONT/SINGL	[ :SOURce<ch>]:SG:TRIGger:TYPE	{CONTInuous  SINGLe}	{CONT  SINGL}	--	
External trigger mode CONT/SINGL/GATED	[ :SOURce<ch>] :SG:TRIGger:EXTernal:TYPE	{CONtinuous  SINGLe  GATE}	{CONT  SINGL  GATE}	--	
External trigger gate EDGE/LEVEL	[ :SOURce<ch>] :SG:TRIGger:EXTernal:GATE:TYPE	{EDGE  LEVe}	{EDGE  LEV}	--	
Number of repetitions (Loop Num) setting	[ :SOURce<ch>]:SG:ROtate	<int>	<int>	--	
Data output start (RUN)/stop (STOP)	[ :SOURce<ch>] :SG:WFM<mno>[:STATe]	{ON OFF}	{ON OFF}	--	*5

\*1: Specifies a 64M memory segment with "S64M," a 32M memory segment with "S32M," and a 16M memory segment with "S16M."

\*2: Sets AUTO if turned "ON."

\*3: The <hex> format represents a hexadecimal format, and the following data are input and output.  
Example: #h1a400 (indicates "1a400" as a hexadecimal number.)

\*4: In <str>, specify a file name that includes a file extension. If the reference directory path is written for the file name, the file of the specified directory can be loaded.  
If the directory path is not specified, it will be handled as a file in the "D:\Advantest\R3681\Waveform" directory.  
Example: "wave0001.awv"  
"D:\Advantest\R3681\Waveform\wave0001.awv"

<str> read by query includes only file name. The directory path cannot be read.

\*5: If turned "ON," specifies RUN. If turned "OFF," specifies STOP.

Function	Command	Parameter	Query	Unit	Remarks
AWG waveform data					
Output data selection	[:SOURCE<ch>] :SG:WFMNumber:SElect:DATA	WAVE1  WAVE2  WAVE3  WAVE4	WAVE1  WAVE2  WAVE3  WAVE4	--	
Data Output Start (RUN) / Stop (STOP) (Starts or stops the output of the waveform data selected in "Output data selection".)	[:SOURCE<ch>] :SG:WFMNumber:SElect[:STATe]	OFF ON	OFF ON	--	
Marker Setup					
Marker output ON/OFF	[:SOURCE<ch>] :SG:MARKer<mkr>:STATe	{ON OFF}	{ON OFF}	--	
Marker mode SEQUENCER/MEMORY	[:SOURCE<ch>] :SG:MARKe:MODE	{SEQ  WFM}	{SEQ  WFM}	--	
Marker polarity POSI/NEGA	[:SOURCE<ch>] :SG:MARKer<mkr>:POLarity	{POSitive  NEGative}	{POS NEG}	--	
Marker setting (StartOffset+Hi+Low)	[:SOURCE<ch>]:SG:MARKer<mkr>	<int>,<int>, <int>	<int>,<int>, <int>	--	*6
Setting number of repetitions of marker output	[:SOURCE<ch>] :SG:MARKer<mkr>:ROTate	<int>	<int>	--	
IQ Output					
Setting the I Gain	[:SOURCE<ch>] :SG:IQADjustment:IGAIn	<real>	<real>	V	
Setting the Q Gain	[:SOURCE<ch>] :SG:IQADjustment:QGAIn	<real>	<real>	V	
Gain IQ value interlock ON/OFF	[:SOURCE<ch>] :SG:IQADjustment:IQGAin:COUple	{ON OFF}	{ON OFF}	--	
Setting I Offset	[:SOURCE<ch>] :SG:IQADjustment:IOFFset	<real>	<real>	V	
Setting Q Offset	[:SOURCE<ch>] :SG:IQADjustment:QOFFset	<real>	<real>	V	
Offset IQ value interlock ON/OFF	[:SOURCE<ch>] :SG:IQADjustment:IQOFFset:COUple	{ON OFF}	{ON OFF}	--	
IQ Output FIX/VARIABLE/OFF	[:SOURCE<ch>] :SG:IQADjustment[:STATe]	{FIXed  VARiable  OFF}	{FIX VAR  OFF}	--	
IQ Output Filter 2.5M/50M/THROUGH	[:SOURCE<ch>]:SG:BBFilter	{FLT2_5M  FLT50M  THRough}	{FLT2_5M  FLT50M  THR}	--	

\*6: The order of response data by the parameter or query is Start Offset of the marker setting, data on the High side, and data on the Low side.

6.5 AWG Button

**6.5 AWG Button**

Function	Command	Parameter	Query	Unit	Remarks
I/Q Input INT/EXT	[ :SOURce<ch=1 2>] :SG:MODulation:SOURce	INTernal  EXTernal	INT EXT	--	
I/Q ATT AUTO/0DB/3DB/6DB	[ :SOURce<ch=1 2>] :SG:MODulation:IQATtenuation	AUTO  IQ0DB  IQ3DB  IQ6DB	AUTO  IQ0DB  IQ3DB  IQ6DB	--	
I/Q Trimming					
Setting I Gain	[ :SOURce<ch=1 2>] :SG:IQADjustment:EXTernal:IGAIn	<int>	<int>	--	
Setting Q Gain	[ :SOURce<ch=1 2>] :SG:IQADjustment:EXTernal:QGAIn	<int>	<int>	--	
Setting I Offset	[ :SOURce<ch=1 2>] :SG:IQADjustment:EXTernal:IOFFset	<int>	<int>	--	
Setting Q Offset	[ :SOURce<ch=1 2>] :SG:IQADjustment:EXTernal :QOFFset	<int>	<int>	--	
Setting I Phase	[ :SOURce<ch=1 2>] :SG:IQADjustment:EXTernal:IPHase	<int>	<int>	--	
Setting Q Phase	[ :SOURce<ch=1 2>] :SG:IQADjustment:EXTernal :QPHase	<int>	<int>	--	
Setting Auto Trimming	[ :SOURce<ch=1 2>] :SG:IQADjustment:EXTernal :OFFSet:AUTO	---	---	--	



## 6.6 AMPL Button

Function	Command	Parameter	Query	Unit	Remarks
Setting Amplitude	[ :SOURce<ch=1 2>] :SG:AMPLitude[:LEVel][:IMMediate] [:AMPLitude]	<real>	<real>	dBm	
Setting Amplitude Step Size	[ :SOURce<ch=1 2>] :SG:AMPLitude[:LEVel][:IMMediate] :STEP	<real>	<real>	dBm	
Amplitude Offset ON/ OFF	[ :SOURce<ch=1 2>] :SG:AMPLitude[:LEVel][:IMMediate] :OFFSet:STATe	OFF ON	OFF ON	--	
Setting Amplitude Offset	[ :SOURce<ch=1 2>] :SG:AMPLitude[:LEVel][:IMMediate] :OFFSet	<real>	<real>	dBm	
Amplitude Relative ON/ OFF	[ :SOURce<ch=1 2>] :SG:AMPLitude:RELative:STATe	OFF ON	OFF ON	--	
Setting Amplitude Upper Limit	[ :SOURce<ch=1 2>] :SG:AMPLitude:LIMit:HIGH	<real>	<real>	dBm	
Setting Amplitude Unit	DISPlay:ANNotation :SG:AMPLitude:UNIT	DBM  DBUV  DBUVEMF	DBM  DBUV  DBUVEMF	--	
ATT Hold ON/OFF	[ :SOURce<ch=1 2>] :SG:AMPLitude:ATTenuation:HOLD	OFF ON	OFF ON	--	
ALC ON/OFF	[ :SOURce<ch=1 2>] :SG:AMPLitude:ALC[:STATe]	OFF ON	OFF ON	--	
ALC mode NORMAL/ HOLD	[ :SOURce<ch=1 2>] :SG:AMPLitude:ALC:MODE	NORMAL  HOLD	NORMAL  HOLD	--	
ALC Hold ADJ	[ :SOURce<ch=1 2>] :SG:AMPLitude:ALC:ADJ	--	--	--	
ALC Detector Auto/CW/MOD	[ :SOURce<ch=1 2>] :SG:AMPLitude:ALC:DETEct	AUTO CW  MOD	AUTO CW  MOD	--	

6.7 FREQ Button

**6.7 FREQ Button**

Function	Command	Parameter	Query	Unit	Remarks
Setting Frequency	[[:SOURce<ch=1 2>] :SG:FREQuency[:CW]	<real>	<real>	Hz	
Setting output channel	[[:SOURce<ch=1 2>] :SG:FREQuency:CHANnels :NUMBer	<int>	<int>	--	
Setting Freq Step Size	[[:SOURce<ch=1 2>] :SG:FREQuency:STEP	<real>	<real>	Hz	
Freq Offset ON/OFF	[[:SOURce<ch=1 2>] :SG:FREQuency:OFFSet:STATe	OFF ON	OFF ON	--	
Setting Freq Offset	[[:SOURce<ch=1 2>] :SG:FREQuency:OFFSet	<real>	<real>	Hz	
Freq Relative ON/OFF	[[:SOURce<ch=1 2>] :SG:FREQuency:RELative:STATe	OFF ON	OFF ON	--	
Channel Setup					
Setting channel start frequency	[[:SOURce<ch=1 2>] :SG:FREQuency:CHANnels:START	<real>	<real>	Hz	
Setting channel step frequency	[[:SOURce<ch=1 2>] :SG:FREQuency:CHANnels:OFFSet	<real>	<real>	Hz	
Setting channel start number	[[:SOURce<ch=1 2>] :SG:FREQuency:CHANnels:START :NUMBer	<int>	<int>	--	

## 6.8 Menu Bar Related Functions

Function	Command	Parameter	Query	Unit	Remarks
Starting BER measurement	:INITiate<ch> :BERT<bch>[:IMMediate]	---	---	--	
BER repeat measurement	:INITiate<ch> :BERT<bch>:CONTInuous	{ON OFF}	{ON OFF}	--	
Stopping BER measurement	:INITiate<ch>:BERT<bch>:ABORt	---	---	--	
Executing AWG Cal	:CALibration:SG:AWG	---	---	--	
Selecting the system					
Spectrum analyzer + SG	:SYSTem:SELEct	SANalyzer, SGENerator	SAN, SGEN	--	*1
Modulation analyzer + SG	:SYSTem:SELEct	MANalyzer, SGENerator	MAN, SGEN		*1
Resetting the current system	:SYSTem:PRESet	---	---	--	
Resetting all measurement systems	:SYSTem:PRESet:ALL	---	---	--	
Save Item	:MMEMory:SELEct:ITEM:SG:SETup	{ON OFF}	{ON OFF}	--	
Save	:MMEMory:STORe:STATe	<int>	---	--	*2
Load	:MMEMory:LOAD:STATe	<int>	---	--	*2
Executing copy output	:HCOPy[:IMMediate]	---	---	--	
Specifying the output destination Hard Disk/Printer	:HCOPy:DESTination	{MMEMory PRINT}	{MMEM PRIN}	--	
Specifying an output file number	:HCOPy:MMEMory:FILE:NUMBer	<int>	<int>	--	
Specifying the output file type Bitmap format/PNG format	:HCOPy:MMEMory:FILE:TYPE	{BITMap PNGraphic}	{BITM PNG}	--	

\*1: To set the SG measurement system to ON, set a combination of Spectrum Analyzer + SG or Modulation Analyzer + SG to ON. The response to the query returns the combination of the measurement system that is currently active.

In addition, the SG system can be turned OFF with “:SYST:SEL SAN|MAN| ...”. In this case, since only the currently selected measurement system is returned as the response to the query, {SAN|MAN| ...} can be read.

For more information on switching the measurement system, refer to the “R3681 Series Programming Guide.”

\*2: Specify to <int> a number with 4 digits at the maximum added to the file name for the object of saving/loading.

For more information, refer to the “R3681 Series Programming Guide.”

6.9 Tool Menu Related Functions

**6.9 Tool Menu Related Functions**

Function	Command	Parameter	Query	Unit	Remarks
Modulation ON/OFF	[ :SOURce<ch=1 2>] :SG:MODulation[:STATe]	OFF ON	OFF ON	--	
RF ON/OFF	[ :SOURce<ch=1 2>]:SG[:STATe]	OFF ON	OFF ON	--	

**6.10 Functions Dedicated to Remote Control**

Function	Command	Parameter	Query	Unit	Remarks
Reading BER questionable status event register	:STATus :QUESTIONable:BERT :EVENT?	---	<int>	--	
Setting BER questionable status event register enable	:STATus :QUESTIONable:BERT :ENABLE	<int>	<int>	--	

## 6.11 Status Register

This instrument has a layered status register structure that is compliant with IEEE standard 488.2-1987, and can send various statuses of the devices to the controller. This section describes the status register to be added by the AWG option.

With respect to the status registers of this instrument, there are five types of registers. However, information related to the status can be added by the AWG option in the two registers shown below:

- Questionable status register
- Measuring status register

Details of the status register in which information is added by the AWG option is shown in Figure 6-1.

---

**MEMO:** *Details of basic status bytes and various status registers are described in the "Programming Guide" attached to the main unit.*

---

6.11 Status Register

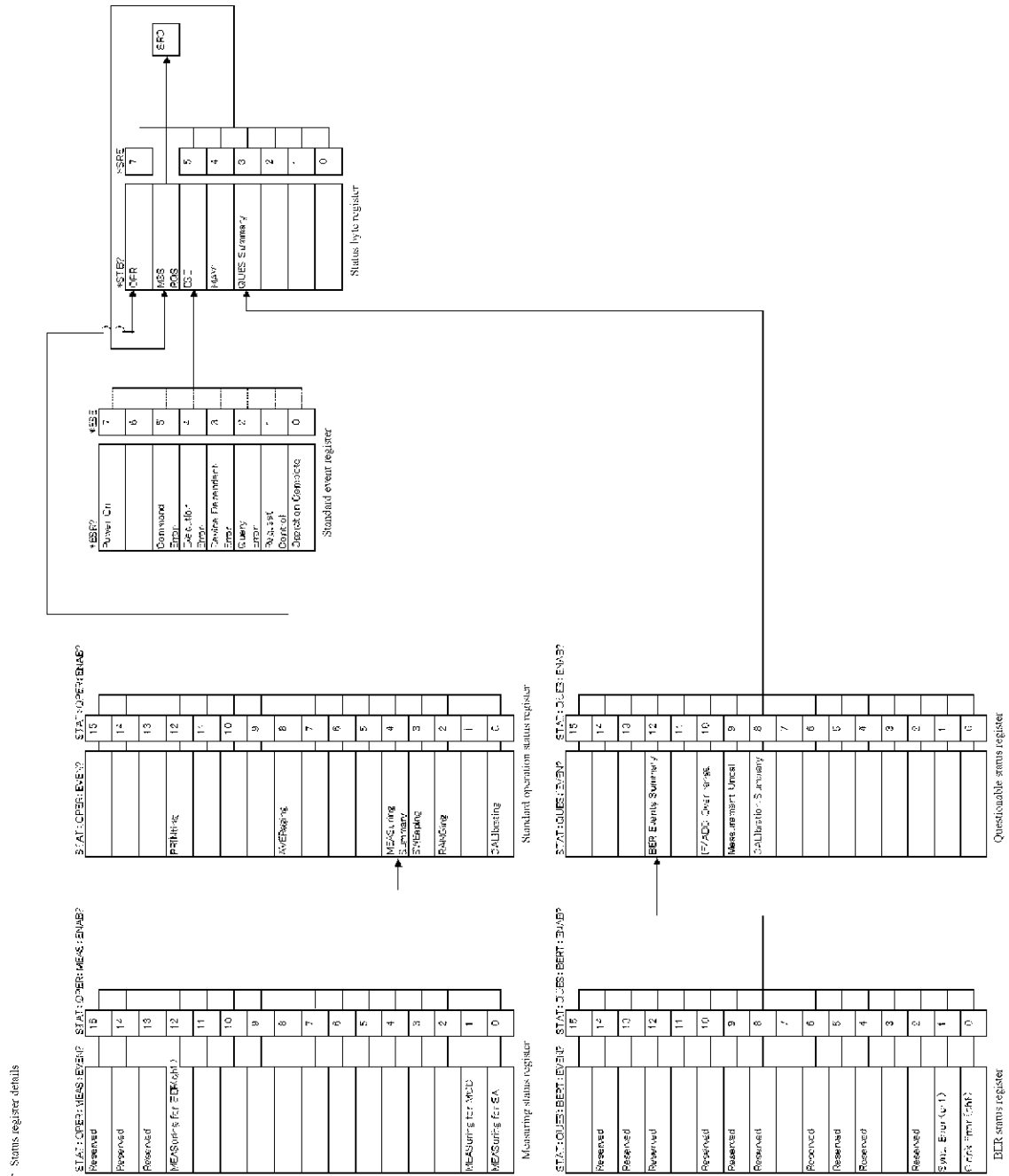

Figure 6-1 Status Register Details

## 6.12 Example of Remote Control Program

This section describes an example of the program for remote control related to the AWG option.

In this program example, Microsoft's Visual Basic is used. When writing a program in another language, change the description to the language used.

In the explanation of this program, a GPIB board manufactured by National Instruments (NI) is assumed as the GPIB bus controller.

---

**MEMO:** For more information on the necessary basic steps with respect to remote control is described in the "R3681 Series Programming Guide" attached to the main unit.

---

### 6.12.1 BER Measurement

This section shows an example of measurement of the BER value with the BER measurement function.

Executing BER measurement and reading the result

```

Rem -----Measure Bit Error Rate -----
Public Sub MeasBer( )

BerStat$ = Space(20)
BerResult$ = Space(100)

Call ibwrt(analyzer%, "*CLS")           ' Clear status registers
Call ibwrt(analyzer%, "*SRE 128")      ' Enable service req. for OPR bit
Call ibwrt(analyzer%, ":STAT:OPER:ENAB 16" ) ' Set event enable for meas. end
Call ibwrt(analyzer%, ":STAT:OPER:MEAS:ENAB 4096") ' Enable BER meas. end event

Call ibwrt(analyzer%, ":SENS:BERT:TBIT 10000") ' Set Meas Bit Length to 10000
Call ibwrt(analyzer%, ":SENS:BERT:TRIG:COUN 1000") ' Set Cycle Count to 1000
Call ibwrt(analyzer%, ":SENS:BERT:TRIG INT") ' Set Start Trigger to Internal
Call ibwrt(analyzer%, ":SENS:BERT:PRBS PN9") ' Set PRBS to PN9
Call ibwrt(analyzer%, ":SENS:BERT:RSYN ON") ' Set Sync Mode to Auto

Call ibwrt(analyzer%, ":INP:BERT:DATA:POL POS") ' Set Data Polarity to Positive
Call ibwrt(analyzer%, ":INP:BERT:CLOC:POL POS") ' Set Clock Slope to Rise
Call ibwrt(analyzer%, ":INP:BERT:CGAT:POL HIGH") ' Set Clock Gate to High
Call ibwrt(analyzer%, ":CALC:BERT:DISP:MODE PERC") ' Set BER Display to %

Call ibwrt(analyzer%, ":INIT:BERT") ' Start Measurement

Call WaitSRQ(boardID%, res%) ' Wait for SRQ using driver's func.
Call ibrsp(analyzer%, stb%) ' Execute serial poll

Call ibwrt(analyzer%, ":CALC:BERT:DATA:BER?") ' Read out Bit Error Rate
Call ibrd(analyzer%, BerResult$)

Call MsgBox("Bit Error Rate = ", BerResult$, "%")

End Sub

```





## 7. SPECIFICATIONS

### 7.1 AWG Specifications

Item	Specification	Remarks
Waveform resolution DAC resolution	14 bits	
The number of channels and the length of the waveform memory The number of channels The maximum length of memory The number of waveforms to be stored	2 64 M samples/channel A maximum of four waveforms	
Waveform amplitude The maximum amplitude of the AC waveform Amplitude variable range Amplitude setting resolution	1 V <sub>P-P</sub> (Fix Gain Path mode) 2 V <sub>P-P</sub> (Variable Gain Path mode) 0.2 V <sub>P-P</sub> to 2 V <sub>P-P</sub> 5 mV	In the Variable Gain Path mode
DC offset Variable range Setting resolution Residual DC offset	±0.75 V 5 mV <±0.5 mV (Fix Gain Path mode) <±1.0 mV (Variable Gain Path mode)	After calibration After calibration
Sampling frequency Frequency setting range Frequency setting resolution	12.5 MHz to 200 MHz 10 μHz	
Amplitude and the phase difference Phase difference between channels Level errors between channels	<2 ns <0.2% (Fix Gain Path mode) <1.0% (Variable Gain Path mode)	After calibration f <sub>out</sub> = 1 kHz After calibration f <sub>out</sub> = 1 kHz

7.1 AWG Specifications

Item	Specification	Remarks
Base band filter	2.5 MHz/50 MHz/Through (Low Path Filter: Tchebyscheff)	
Distortion characteristics SFDR	<-67 dBc (Fix Gain Path mode) <-61 dBc (Variable Gain Path mode)	Sampling Clock = 200 MHz f <sub>out</sub> = 5 MHz, Sine wave Output Level = 1 V <sub>P-P</sub> Output Level = 2 V <sub>P-P</sub>
Start trigger Type Source Trigger polarity	Continuous, single, and gated Internal and external Positive and negative	
Marker Mode Marker polarity The number of markers	Memory marker and sequence marker Positive and negative 2	One of the markers is internally connected to the analyzer.
BER counter PRBS The number of channels Clock rate External input signal Data polarity Clock polarity	PN7, 9, 11, 15, 19, 20, 23, ALL0, ALL1 1 <60 MHz Data, clock, clock gate, and reset Positive and negative Rising and falling	
Input and output I/Q output Marker output BER data input BER clock input BER clock gate input BER reset input	SMA (f), rear panel, 50 Ω (nominal) BNC (f), rear panel, 180 Ω (nominal) TTL level BNC (f), rear panel, 5 kΩ (nominal) TTL level or LVTTTL level BNC (f), rear panel, 5 kΩ (nominal) TTL level or LVTTTL level BNC (f), rear panel, 5 kΩ (nominal) TTL level or LVTTTL level BNC (f), rear panel, 5 kΩ (nominal) TTL level or LVTTTL level	

## 7.2 SG Specifications

Item	Specification	Remarks										
Frequency												
Range	50 MHz to 6 GHz (R3681) 50 MHz to 3 GHz (R3671)											
Resolution	0.1 Hz											
Accuracy	Depending on the reference signal source accuracy											
Output level												
Range	+13 dBm to -100 dBm (Modulation: OFF) +10 dBm to -100 dBm (Modulation: ON)											
Variable range of the attenuator hold level	>10 dB <sub>p,p</sub>											
Resolution	0.01 dB											
Accuracy *1	<±1.4 dB (+13 dBm to -15 dBm, Modulation: OFF), ±1.0 dB (2 Sigma) <±1.8 dB (-15 dBm to -100 dBm, Modulation: OFF), ±1.2 dB (2 Sigma) <±1.4 dB (+10 dBm to -15 dBm, Modulation: ON), ±1.0 dB (2 Sigma) <±2.3 dB (-15 dBm to -100 dBm, Modulation: ON), ±1.6 dB (2 Sigma)											
ALC Hold ADJ accuracy	<±0.25 dB (Relative to ALC ON)											
Output impedance	50 Ω nominal value, front panel N(f)											
SWR *2	<1.7 : ≤3 GHz <2.0 : ≤6 GHz											
Maximum reverse input power	1W											
Signal purity												
SSB phase noise (20 kHz offset)	<table border="1"> <thead> <tr> <th>R3681</th> <th>R3671</th> </tr> </thead> <tbody> <tr> <td>&lt;-115 dBc/1Hz (50 MHz ≤ f ≤ 500 MHz)</td> <td>&lt;-115 dBc/1Hz (50 MHz ≤ f ≤ 500 MHz)</td> </tr> <tr> <td>&lt;-123 dBc/Hz (500 MHz &lt; f ≤ 2 GHz)</td> <td>&lt;-123 dBc/Hz (500 MHz &lt; f ≤ 2 GHz)</td> </tr> <tr> <td>&lt;-118 dBc/Hz (2 GHz &lt; f ≤ 4 GHz)</td> <td>&lt;-118 dBc/Hz (2 GHz &lt; f ≤ 3 GHz)</td> </tr> <tr> <td>&lt;-115 dBc/Hz (4 GHz &lt; f ≤ 6 GHz)</td> <td>-</td> </tr> </tbody> </table>	R3681	R3671	<-115 dBc/1Hz (50 MHz ≤ f ≤ 500 MHz)	<-115 dBc/1Hz (50 MHz ≤ f ≤ 500 MHz)	<-123 dBc/Hz (500 MHz < f ≤ 2 GHz)	<-123 dBc/Hz (500 MHz < f ≤ 2 GHz)	<-118 dBc/Hz (2 GHz < f ≤ 4 GHz)	<-118 dBc/Hz (2 GHz < f ≤ 3 GHz)	<-115 dBc/Hz (4 GHz < f ≤ 6 GHz)	-	
R3681	R3671											
<-115 dBc/1Hz (50 MHz ≤ f ≤ 500 MHz)	<-115 dBc/1Hz (50 MHz ≤ f ≤ 500 MHz)											
<-123 dBc/Hz (500 MHz < f ≤ 2 GHz)	<-123 dBc/Hz (500 MHz < f ≤ 2 GHz)											
<-118 dBc/Hz (2 GHz < f ≤ 4 GHz)	<-118 dBc/Hz (2 GHz < f ≤ 3 GHz)											
<-115 dBc/Hz (4 GHz < f ≤ 6 GHz)	-											
Broadband noise	<-132 dBc/Hz (When 2 GHz and 0 dBm are output)											
Harmonics	<-30 dBc (When +10 dBm is output)											
Non-harmonics	<-65 dBc (When 0 dBm is output)											

\*1: Temperature range: 25°C ±5°C

\*2: Output level: -10 dBm or less

7.2 SG Specifications

Item	Specification	Re marks
Modulation *1 *3 Modulation accuracy *4 Origin offset ACLR *5	EVM<4 %rms <-15 dBc <-53 dBc (Basic) <-60 dBc (Option 73 ACLR mode)	
External IQ input Input level Impedance	$\sqrt{I^2 + Q^2} = 0.5 \text{ Vrms}$ 50 $\Omega$ nominal value, rear panel SMA(f)	
General specifications Operating environmental range Storage environmental range	Ambient temperature: +5 °C to +40 °C Relative humidity: 80% or less (no condensation) Ambient temperature: -20 °C to +60 °C Relative humidity: 80% or less (no condensation)	

- \*3: 3GPP  
IEEE802.11b/g  
When 0 dBm is output
- \*4: Carrier-Shift 2.5 MHz (In 3GPP)
- \*5: 3GPP DL Test Model I 64DPCH  
2110 MHz to 2170 MHz

## 8. PERFORMANCE VERIFICATION

### 8.1 Overview

#### 8.1.1 Introduction

This chapter describes the performance verification procedure in order of the items listed in Table 8-1 and Table 8-2.

Table 8-1 Performance Verification List (AWG)

Test No.	Test item
8.3.1	Signal Output
8.3.2	Output Amplitude
8.3.3	Residual DC Offset
8.3.4	DC Offset
8.3.5	Sampling Frequency
8.3.6	Phase Difference between Channels
8.3.7	SFDR
8.3.8	Internal Filter
8.3.9	External Start Trigger
8.3.10	Marker 1 Output
8.3.11	Marker 2 Output
8.3.12	Bit Error Rate Counter

8.1.1 Introduction

Table 8-2 Performance Verification List (SG)

Test No.	Test item
8.5.1	Frequency Accuracy
8.5.2	Level Accuracy
8.5.3	Attenuator Hold Level Variable Range
8.5.4	ALC Hold ADJ Accuracy
8.5.5	SSB Phase Noise
8.5.6	Broadband Noise
8.5.7	Harmonics
8.5.8	Non-harmonics
8.5.9	Modulation Accuracy
8.5.10	Origin Offset
8.5.11	ACLR
8.5.12	External IQ Input

1. Testing environment and conditions

Conduct performance verification under the following conditions.

- In a 20 °C to 30 °C environment, after turning on the power and letting it warm up for 30 minutes or longer
- After automatic calibration has been performed

2. Required measurement instruments

Table 8-3 and Table 8-4 show the list of instruments which are required in all tests. Instruments which are required for individual tests are also listed in each test.

If the user's instruments meet the specifications described in the table, those instruments can be used instead of the recommended models.

3. Cycle of performance verification

It is recommended that performance be verified once a year to check whether the SG+AWG option meets its specifications.

4. Performance verification sheets

Performance verification sheets are provided at the end of this chapter for the user to record the values which are measured in each performance verification test.

When conducting performance verification, it is recommended that copies of the sheets be made for the test results, and the sheets stored as test records.

### 8.1.2 Required Instruments

Table 8-3 and Table 8-4 show a list of required instruments.

Instruments which are required in all tests are listed. Instruments which are required for individual tests are also listed in each test.

If the user's instruments meet the specifications described in the table, those instruments can be used instead of the recommended models.

Table 8-3 Required Instruments List (AWG)

No.	Instrument	Requirements	Recommended model	Quantity
1	Oscilloscope	Band: >500 MHz Input: 1 M $\Omega$ / 50 $\Omega$ 2 CH Error in delay between channels: <100 ps	TDS5052 Tektronix	1
2	Digital multimeter	Function: DCV, ACV DCV measurement accuracy: 1 mV to 1.5 V <0.01% ACV measurement accuracy: 0.1 V to 2 V <0.1%	R6552 ADVANTEST	1
3	Function generator	TTL level Square-wave output	33120A Agilent Technologies	1
4	BNC cable	Impedance: 50 $\Omega$ Connector: BNC(m)-BNC(m) Length: 1.5 m	A01037-1500 ADVANTEST	3
5	Adapter	Connector: SMA(m)-BNC(f)	HRM-517 (09) HIROSE	2
6	Adapter	Connector: BNC(f)-BANANA(m)	103-0090-00 Tektronix	1
7	Adapter	Connector: SMA(f)-SMA(f)	HRM-501 HIROSE	1

8.1.2 Required Instruments

Table 8-4 Required Instruments List (SG)

No.	Instrument	Requirements	Recommended model	Quantity
1	Power meter	NRV series Compatible power sensor Resolution: 0.01 dB Relative measurement mode Reference accuracy: 0.9%	NRVS Rohde & Schwarz	1
2	Power sensor	Frequency range: 50 MHz to 40 GHz Input level: 1 $\mu$ W to 100 mW VSWR: 1.3 (40 GHz)	NRV-Z55 Rohde & Schwarz	1
3	RF cable	Impedance: 50 $\Omega$ Connector: K(m)-K(m) Length: 0.7 m	SF102 SUHNUR	1
4	RF cable	Impedance: 50 $\Omega$ Connector: BNC(m)-BNC(m) Length: 1.5 m	A01037-1500 ADVANTEST	3
5	Adapter	Connector: K(f)-K(f)	5A-SFF40(A) ADVANTEST	1
6	Adapter	Connector: SMA(m)-BNC(f)	HRM-517(09) HIROSE	4
7	Adapter	Connector: N(m)-SMA(f)	HRM-554S HIROSE	1
8	Adapter	Connector: N(m)-BNC(f)	JUG-201A/U HIROSE	2



## 8.2 Loading Waveform Data

This section describes procedures for loading the waveform data, which is required for the performance verification, to the waveform storing memory of the digital signal generation option.

The waveform file is stored in advance in the following directory of the R3681 series built-in hard disk.

D:\Advantest\R3681\Waveform\

Refer also to 4.3.1, "Operation from Waveform File Loading to I/Q Signal Output" in which operation examples of the waveform data loading is described.

### Procedure

1. Select the SG+AWG option.  
Operation: [Config]→[SG+AWG Option]
2. Display the setting dialog box which is related to loading the waveform data.  
Operation: [AWG], [Waveform Setup]
3. Select the split mode of the waveform storing memory.
  - When setting the 64M × 1 waveform mode:  
Operation: [Memory Segments], [64M Word × 1]
  - When setting the 32M × 2 waveform mode:  
Operation: [Memory Segments], [32M Word × 2]
  - When setting the 16M × 4 waveform mode:  
Operation: [Memory Segments], [16M Word × 4]
4. Press the OK button in the displayed verification message box to change the split mode of the waveform storing memory.  
Operation: [Confirmation], [OK]
5. Select the map which loads the waveform data.  
Operation: [Load Waveform], [Map Number], [Wave 1]
6. Verify that Auto Load is set.  
If Auto Load is not set, touch the checkbox to set Auto Load.  
Operation: [Load Waveform], [Auto Load]
7. Display the dialog box which specifies the waveform file to be loaded.  
Operation: [Waveform Setup], [Load File]
8. Touch the waveform file to be loaded to select it.
9. Waveform data loading starts.  
Operation: [Select Waveform], [Load]
10. When the waveform data loading is complete, the [Select Waveform] dialog box closes and the number, the loaded file name, and data size are displayed in [AWG Memory Mapping Information] of the [Waveform Setup] dialog box.

## 8.2 Loading Waveform Data

11. Change the map and repeat steps 5 to 10 when loading other waveform data in the  $32\text{M} \times 2$  waveform mode or  $16\text{M} \times 4$  waveform mode.
12. After all waveform data are loaded, close the **[Waveform Setup]** dialog box.  
Operation: **[Waveform Setup]**, [**X**]

### 8.3 AWG Performance Verification Procedure

This section describes the performance verification procedure in order of the items listed in Table 8-1.

#### 8.3.1 Signal Output

[Overview]

This section is to verify that the signal is output with the waveform data stored in the waveform memory. Conduct verification for three types of waveform storing memory split modes.

[Required instruments]

Instrument	Quantity	Recommended model
Oscilloscope	1	TDS5052
BNC cable BNC(m)-BNC(m)	2	A01037-1500
Adapter SMA(m)-BNC(f)	2	HRM-517 (09)

[Connection diagram]

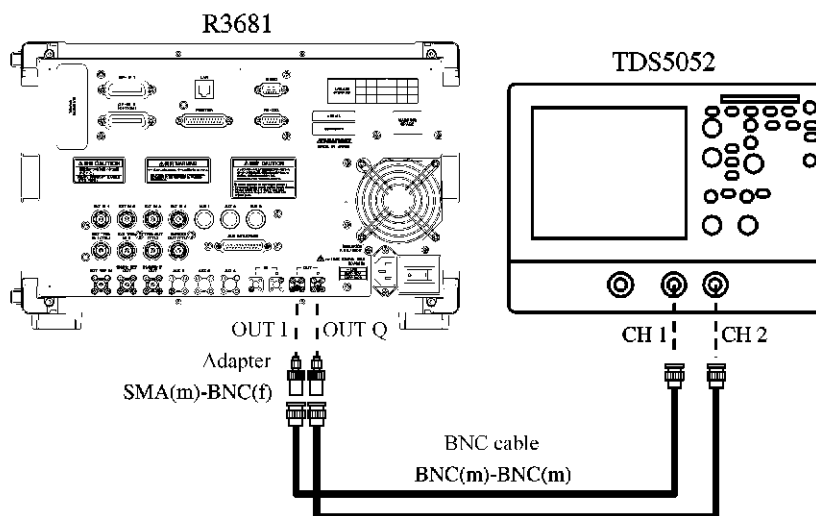

Figure 8-1 Signal Output Accuracy Test Connection Diagram

[Test procedure]

Initialization

1. Preset this instrument.

Operation: **[Special]**→**[Preset]**→**[All]**

### 8.3.1 Signal Output

#### Connecting the instruments

2. Connect the instruments as shown in Figure 8-1.

#### Setting the oscilloscope

3. Set the oscilloscope as follows:

Vertical axis	CH1 and CH2
Input coupling:	DC
Scale:	500 mV/div
Input impedance:	50 $\Omega$
Horizontal axis	
Sweep:	Table 8-5 horizontal axis setting
Trigger	
Source:	CH1
Coupling:	DC
Slope:	Positive
Level:	0 V
Mode:	Auto

#### Setting the AWG option

4. Referring to 8.2, "Loading Waveform Data," set the waveform storing memory split mode shown in Table 8-5 in accordance with the item to be checked and load the corresponding waveform file.
5. Set the output waveform shown in Table 8-5 in accordance with the item to be checked.  
Operation: **Output Setup**, **[Output Waveform Select]**
6. After the setting is completed, close the **[Output Setup]** dialog box.  
Operation: **[Output Setup]**, **[X]**
7. Set the I/Q output mode to Fix Gain Path.  
Operation: **I/Q Output**, **[I/Q Output]**, **[Fix Gain Path (1V<sub>p-p</sub>)]**
8. After the setting is completed, close the **[I/Q Output Control]** dialog box.  
Operation: **[I/Q Output Control]**, **[X]**
9. Output the signal.  
Operation: **[AWG ON]**

## Verifying output

10. Observe the period of the output signal by using the oscilloscope. Verify that the period is one shown in Table 8-5, in accordance with the item to be checked.  
The period measurement does not have to be exact.
11. Stop the signal output.  
Operation: [AWG ON]
12. Repeat steps 3 to 11 to verify signal output for three types of waveform memory modes.

Table 8-5 Signal Output Verification Setting List

Item to be checked	Memory Segment	Waveform file	Output waveform	Setting for the horizontal axis of the oscilloscope	Waveform period (reading value)
64M × 1 waveform	64M word × 1	SINWV1	Wave 1	20 μs/div	100 μs (5 div)
32M × 2 waveform	32M word × 2	SINWV1	Wave 1	20 μs/div	100 μs (5 div)
		SINWV2	Wave 2	10 μs/div	50 μs (5 div)
16M × 4 waveform	16M word × 4	SINWV1	Wave 1	20 μs/div	100 μs (5 div)
		SINWV2	Wave 2	10 μs/div	50 μs (5 div)
		SINWV3	Wave 3	4 μs/div	20 μs (5 div)
		SINWV4	Wave 4	2 μs/div	10 μs (5 div)

8.3.2 Output Amplitude

8.3.2 Output Amplitude

[Overview]

Outputs a 1 kHz sine wave and measures the amplitude with the digital multimeter.

In the Fix Gain Path mode, 1  $V_{P-P}$  output amplitude is measured, and in the Variable Gain Path mode, 200 m $V_{P-P}$ , 1  $V_{P-P}$  and 2  $V_{P-P}$  output amplitudes are measured.

The level error between channels is calculated by measuring the output amplitude of I channel output and Q channel output.

Because measurement by a digital multimeter is performed, no 50  $\Omega$  termination is provided.

Therefore, pay attention that the output amplitude becomes a voltage equivalent to double the set value.

[Specifications]

AC waveform maximum amplitude: 1  $V_{P-P}$  (Fix Gain Path mode)  
 2  $V_{P-P}$  (Variable Gain Path mode)

Level error between channels:  $\pm 0.2\%$  or lower (Fix Gain Path mode)  
 $\pm 1.0\%$  or lower (Variable Gain Path mode)  
 (Level Q – Level I) / Level I  $\times 100\%$

[Required instruments]

Instrument	Quantity	Recommended model
Digital multimeter	1	R6552
BNC cable BNC(m)-BNC(m)	1	A01037-1500
Adapter SMA(m)-BNC(f)	1	HRM-517 (09)
Adapter BNC(f)-BANANA(m)	1	103-0090-00

[Connection diagram]

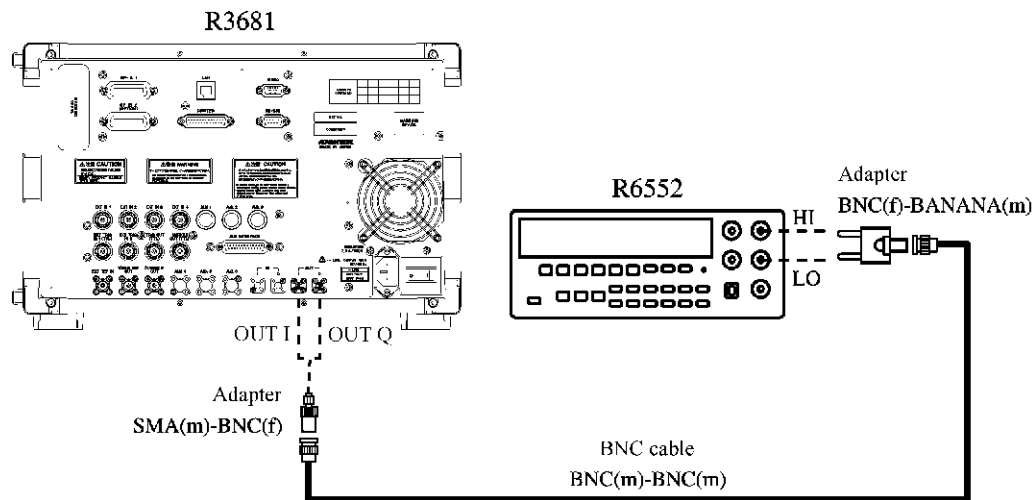

Figure 8-2 Output Amplitude Verification Connection Diagram

[Test procedure]

Initialization

1. Preset this instrument.  
Operation: **[Special]→[Preset]→[All]**

Connecting the instruments

2. Connect the instruments as shown in Figure 8-2.

Setting the digital multimeter

3. Set the digital multimeter as follows:
 

Function:	ACV
Range:	AUTO
Sampling rate:	SLOW

Setting the AWG option and measurement

4. Referring to 8.2, "Loading Waveform Data," load the waveform file SINWV5.
5. Set the I/Q output mode to Fix Gain Path.  
Operation: **[I/Q Output]**, **[I/Q Output]**, **[Fix Gain Path (1V<sub>p-p</sub>)]**
6. After the setting is completed, close the **[I/Q Output Control]** dialog box.  
Operation: **[I/Q Output Control]**, **[×]**
7. Output the signal.  
Operation: **[AWG ON]**
8. Measure the voltage of I ch output with the digital multimeter and record the measurement.  
(Fix level I)
9. Measure the voltage of Q ch output with the digital multimeter and record the measurement.  
(Fix level Q)
10. Stop the signal output.  
Operation: **[AWG ON]**
11. Set the I/Q output mode to 200 mV<sub>p-p</sub> output in the Variable Gain Path mode.  
Operation: **[I/Q Output]**, **[I/Q Output]**, **[Variable Gain Path]**, **[I]**, **[2]**, **[0]**, **[0]**, **[ENT]**
12. After the setting is completed, close the **[I/Q Output Control]** dialog box.  
Operation: **[I/Q Output Control]**, **[×]**

8.3.2 Output Amplitude

13. Output the signal.  
Operation: **[AWG ON]**
14. Measure the voltage of I ch output with the digital multimeter and record the measurement.  
(Var 200 mV level I)
15. Measure the voltage of Q ch output with the digital multimeter and record the measurement.  
(Var 200 mV level Q)
16. Set the output amplitude to 1 V<sub>P-P</sub>.  
Operation: **[I/Q Output]**, **[I/Q Output]**, **[Variable Gain Path]**, **[I]**, **[1]**, **[0]**, **[0]**, **[0]**, **[ENT]**
17. After the setting is completed, close the **[I/Q Output Control]** dialog box.  
Operation: **[I/Q Output Control]**, **[X]**
18. Measure the voltage of I ch output with the digital multimeter and record the measurement.  
(Var 1 V level I)
19. Measure the voltage of Q ch output with the digital multimeter and record the measurement.  
(Var 1 V level Q)
20. Set the output amplitude to 2 V<sub>P-P</sub>.  
Operation: **[I/Q Output]**, **[I/Q Output]**, **[Variable Gain Path]**, **[I]**, **[2]**, **[0]**, **[0]**, **[0]**, **[ENT]**
21. After the setting is completed, close the **[I/Q Output Control]** dialog box.  
Operation: **[I/Q Output Control]**, **[X]**
22. Measure the voltage of I ch output with the digital multimeter and record the measurement.  
(Var 2 V level I)
23. Measure the voltage of Q ch output with the digital multimeter and record the measurement.  
(Var 2 V level Q)
24. Stop the signal output.  
Operation: **[AWG ON]**

Calculating the level error between channels

25. For all of 200 mV<sub>P-P</sub>, 1 V<sub>P-P</sub> and 2 V<sub>P-P</sub> for the Variable Gain Path mode and Fix Gain Path mode, calculate the level error between channels using the following formula.  
$$(\text{Level Q} - \text{Level I}) / \text{Level I} \times 100\%$$
26. Verify that the calculated level error between channels is within  $\pm 0.2\%$  for the Fix Gain Path mode and within  $\pm 1.0\%$  for the Variable Gain Path mode.



### 8.3.3 Residual DC Offset

#### [Overview]

This section describes how to measure the residual DC offset.

Measure the I ch output and Q ch output in the Fix Gain Path mode and Variable Gain Path mode.

Because measurement by a digital multimeter is performed, no 50  $\Omega$  termination is provided.

Therefore, pay attention that the output voltage measurement becomes a value equivalent to double the value for the 50  $\Omega$  terminated case.

#### [Specifications]

Residual DC offset:  $\pm 0.5$  mV (Fix Gain Path mode)  
 $\pm 1.0$  mV (Variable Gain Path mode)

#### [Required instruments]

Instrument	Quantity	Recommended model
Digital multimeter	1	R6552
BNC cable BNC(m)-BNC(m)	1	A01037-1500
Adapter SMA(m)-BNC(f)	1	HRM-517 (09)
Adapter BNC(f)-BANANA(m)	1	103-0090-00

#### [Connection diagram]

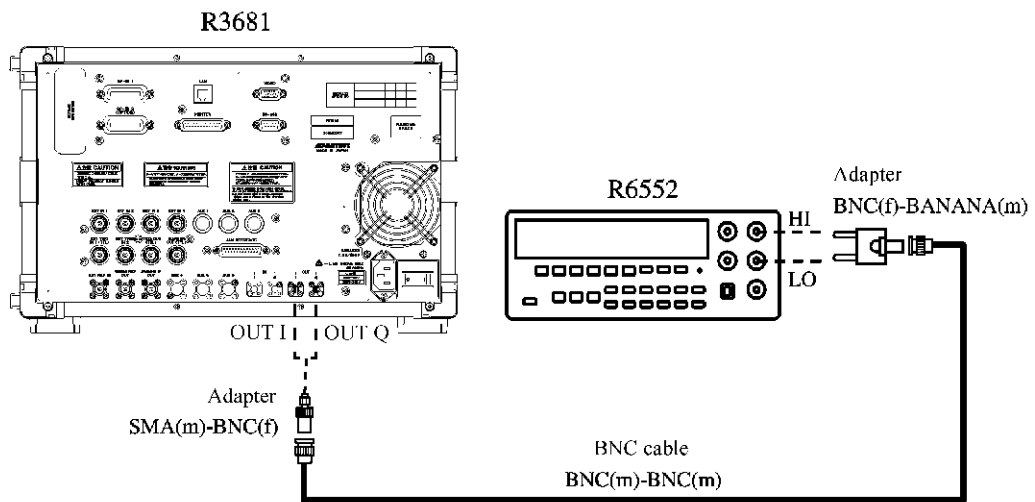

Figure 8-3 Residual DC Offset Measurement Connection Diagram

### 8.3.3 Residual DC Offset

[Test procedure]

Initialization

1. Preset this instrument.  
Operation: **[Special]→[Preset]→[All]**

Connecting the instruments

2. Connect the instruments as shown in Figure 8-3.

Setting the digital multimeter

3. Set the digital multimeter as follows:  
Function: DCV  
Range: AUTO  
Sampling rate: SLOW

Setting the AWG option and measurement

4. Referring to 8.2, "Loading Waveform Data," load the waveform file DC0.
5. Verify that the set value for the DC offset is 0 mV. If not, set the DC offset to 0 mV.  
Operation: **[I/Q Output]**, **[I/Q Offset]**, **[I]**, **[0]**, **[ENT]**
6. Set the I/Q output mode to Fix Gain Path.  
Operation: **[I/Q Output]**, **[Fix Gain Path (1V<sub>P-P</sub>)]**
7. After the setting is completed, close the **[I/Q Output Control]** dialog box.  
Operation: **[I/Q Output Control]**, **[×]**
8. Output the signal.  
Operation: **[AWG ON]**
9. Measure the voltage of I ch output with the digital multimeter.
10. Measure the voltage of Q ch output with the digital multimeter.
11. Verify that the measured voltage is within  $\pm 1.0$  mV.
12. Set the I/Q output mode to the Variable Gain Path mode.  
Operation: **[I/Q Output]**, **[I/Q Output]**, **[Variable Gain Path]**
13. After the setting is completed, close the **[I/Q Output Control]** dialog box.  
Operation: **[I/Q Output Control]**, **[×]**
14. Measure the voltage of I ch output with the digital multimeter.
15. Measure the voltage of Q ch output with the digital multimeter.

16. Verify that the measured voltage is within  $\pm 2.0$  mV.
17. Stop the signal output.  
Operation: **[AWG ON]**

8.3.4 DC Offset

8.3.4 DC Offset

[Overview]

This section describes how to verify the DC offset setting.

Measure the I ch output and Q ch output.

Because measurement by a digital multimeter is performed, no 50 Ω termination is provided.

Therefore, pay attention that the output voltage becomes a voltage equivalent to double the set value.

[Specifications]

DC offset setting range: ±0.75 V

[Required instruments]

Instrument	Quantity	Recommended model
Digital multimeter	1	R6552
BNC cable BNC(m)-BNC(m)	1	A01037-1500
Adapter SMA(m)-BNC(f)	1	HRM-517 (09)
Adapter BNC(f)-BANANA(m)	1	103-0090-00

[Connection diagram]

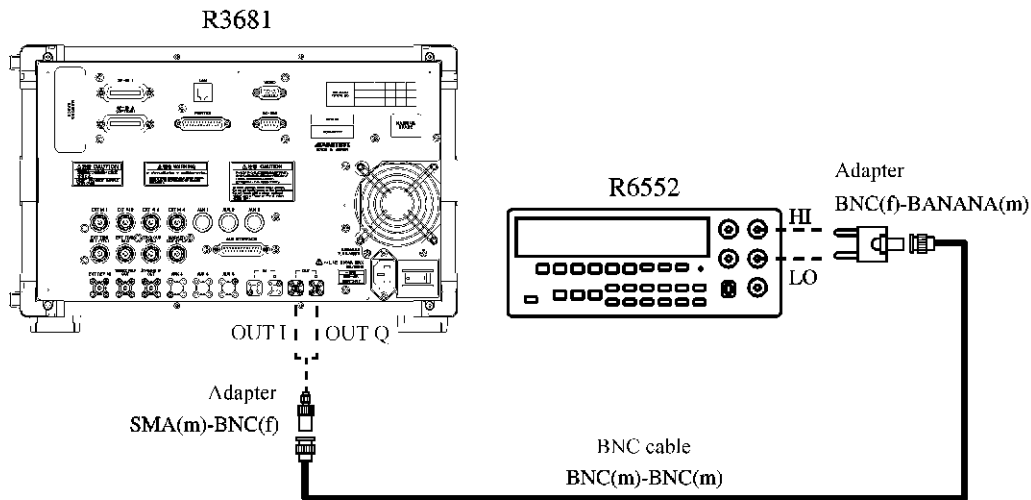

Figure 8-4 DC Offset Verification Connection Diagram

[Test procedure]

Initializing

1. Preset this instrument.  
Operation: [Special]→[Preset]→[All]

## Connecting the instruments

2. Connect the instruments as shown in Figure 8-4.

## Setting the digital multimeter

3. Set the digital multimeter as follows:
 

Function:	DCV
Range:	AUTO
Sampling rate:	SLOW

## Setting the AWG option and measurement

4. Referring to 8.2, "Loading Waveform Data," load the waveform file DC0.
5. Set the I/Q output mode to Fix Gain Path.  
Operation: **I/Q Output**, **I/Q Output**, **Fix Gain Path (1V<sub>p-p</sub>)**
6. Set the DC offset to +750 mV.  
Operation: **I/Q Offset**, **I**, **7**, **5**, **0**, **ENT**
7. After the setting is completed, close the **I/Q Output Control** dialog box.  
Operation: **I/Q Output Control**, **[X]**
8. Output the signal.  
Operation: **AWG ON**
9. Measure the voltage of I ch output with the digital multimeter.
10. Measure the voltage of Q ch output with the digital multimeter.
11. Verify that the measured voltage is +1.5 V  $\pm$ 1%.
12. Set the DC offset to -750 mV.  
Operation: **I/Q Output**, **I/Q Offset**, **I**, **-**, **7**, **5**, **0**, **ENT**
13. After the setting is completed, close the **I/Q Output Control** dialog box.  
Operation: **I/Q Output Control**, **[X]**
14. Measure the voltage of I ch output with the digital multimeter.
15. Measure the voltage of Q ch output with the digital multimeter.
16. Verify that the measured voltage is -1.5 V  $\pm$ 1%.
17. Stop the signal output.  
Operation: **AWG ON**

8.3.5 Sampling Frequency

8.3.5 Sampling Frequency

[Overview]

This section describes sampling frequency verification, in which a sine wave that is a quarter of sampling frequency is output and the frequency of the output signal is measured.

The frequency is measured by using the frequency counter function of the R3681 series main unit SA.

[Required instruments]

Instrument	Quantity	Recommended model
BNC cable BNC(m)-BNC(m)	1	A01037-1500
Adapter SMA(m)-BNC(f)	2	HRM-517 (09)
Adapter SMA(f)-SMA(f)	1	HRM-501

[Connection diagram]

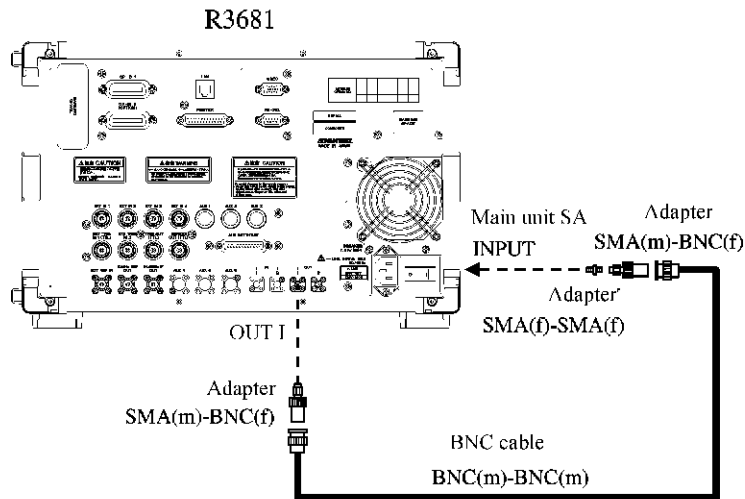

Figure 8-5 Sampling Frequency Verification Connection Diagram

[Test procedure]

Initialization

1. Preset this instrument.  
Operation: [Special]→[Preset]→[All]

Connecting the instruments

2. Connect the instruments as shown in Figure 8-5.

## Setting the R3681 series main unit SA

3. Set the center frequency of this instrument to 50 MHz.  
Operation: {FREQ}, **Center**, **5**, **0**, **M/n**
4. Set the frequency span to 100 kHz.  
Operation: {SPAN}, **Span**, **1**, **0**, **0**, **k/μ**
5. Set the reference level to 10 dBm.  
Operation: {LEVEL}, **Ref Level**, **1**, **0**, **ENT**
6. Turn on the counter function.  
Operation: {MENU2}, {MEAS}, **Counter**

## Setting the AWG option and measurement

7. Referring to 8.2, "Loading Waveform Data," load the waveform file SINWV6.
8. Set the I/Q output mode to Fix Gain Path.  
Operation: **I/Q Output**, **I/Q Output**, **Fix Gain Path (1V<sub>p-p</sub>)**
9. After the setting is completed, close the **I/Q Output Control** dialog box.  
Operation: **I/Q Output Control**, [×]
10. Set the sampling frequency to 200 MHz.  
Operation: **Output Setup**, **Sampling Freq**, **2**, **0**, **0**, **M/n**
11. After the setting is completed, close the **Output Setup** dialog box.  
Operation: **Output Setup**, [×]
12. Output the signal.  
Operation: **AWG ON**
13. Make the main unit SA active.  
Operation: **SA↔SG**
14. Measure the frequency by peak search by SA.  
Operation: **SEARCH**
15. Verify that the measured frequency is within 50 MHz ±0.01 Hz.
16. Make AWG active and stop the signal output.  
Operation: **SA↔SG**, **AWG ON**

8.3.5 Sampling Frequency

Verification with other sampling frequencies

17. Repeat step 3 and steps 10 to 16 to verify the frequency against each sampling frequency shown in Table 8-6.

If the setting screen is not displayed when setting SA or AWG, touch the [SA↔SG] button to switch the active setting screen.

Table 8-6 Setting Center Frequency for Sampling Frequency and Frequency Reference Value

AWG option sampling frequency	R3681 series main unit SA center frequency	Frequency reference value for measurement
200 MHz	50 MHz	50 MHz ±0.01 Hz
100 MHz	25 MHz	25 MHz ±0.01 Hz
12.5 MHz	3.125 MHz	3.125 MHz ±0.01 Hz



### 8.3.6 Phase Difference between Channels

[Overview]

This section describes measurement with the oscilloscope of the phase difference between channels by outputting the same square wave from the I ch output and the Q ch output.

[Specifications]

Phase difference between channels: 2 ns or less

[Required instruments]

Instrument	Quantity	Recommended model
Oscilloscope	1	TDS5052
BNC cable BNC(m)-BNC(m)	2	A01037-1500
Adapter SMA(m)-BNC(f)	2	HRM-517 (09)

[Connection diagram]

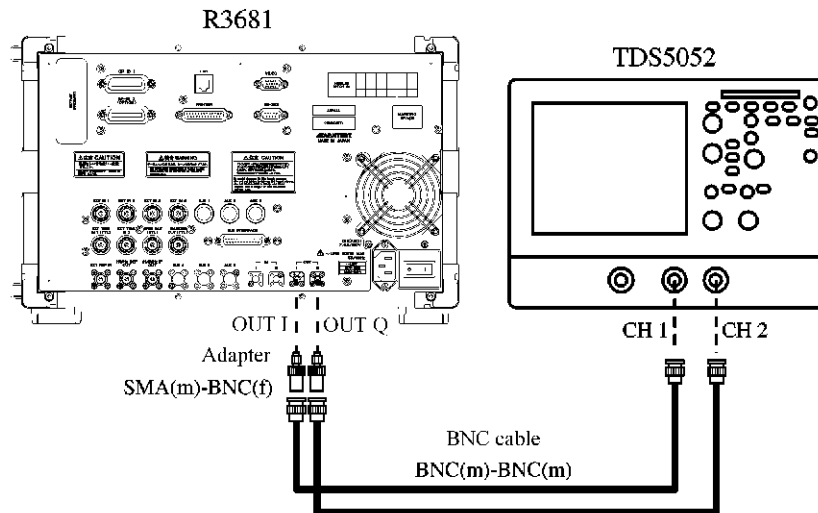

Figure 8-6 Phase Difference between Channels Measurement Connection Diagram

[Test procedure]

Initialization

1. Preset this instrument.  
Operation: **[Special]**→**[Preset]**→**[All]**

Connecting the instruments

2. Connect the instruments as shown in Figure 8-6.

### 8.3.6 Phase Difference between Channels

#### Setting the oscilloscope

3. Set the oscilloscope as follows:

Vertical axis	CH1 and CH2
Input coupling:	DC
Scale:	200 mV/div
Input impedance:	50 $\Omega$
Horizontal axis	
Sweep:	200 ps/div
Trigger	
Source:	CH1
Coupling:	DC
Slope:	Positive
Level:	0 V
Mode:	Auto

#### Setting the AWG option

4. Referring to 8.2, "Loading Waveform Data," load the waveform file SQWV.
5. Set the I/Q output mode to Fix Gain Path.  
Operation: **[I/Q Output]**, **[I/Q Output]**, **[Fix Gain Path (1V<sub>p-p</sub>)]**
6. After the setting is completed, close the **[I/Q Output Control]** dialog box.  
Operation: **[I/Q Output Control]**, **[X]**
7. Output the signal.  
Operation: **[AWG ON]**

#### Measuring the phase difference between channels

8. Measure with the oscilloscope the time difference at the zero cross-point between the I ch output waveform and the Q ch output waveform.
9. Verify that the time difference at the zero cross-point is within 2 ns (10 div).
10. Stop the signal output.  
Operation: **[AWG ON]**

### 8.3.7 SFDR

#### [Overview]

This section describes the method to verify SFDR by measuring all “spurious responses” including harmonic distortion of the output signal, with the R3681 series main unit SA.

Measure SFDR when a 5 MHz sine wave is output with a sampling frequency of 200 MHz.

Because folding-back occurs in a range higher than the Nyquist frequency that is the sampling frequency /2 in signal generation by DAC, SFDR is measured at a Nyquist frequency 100 MHz or lower.

Measure the I ch output and Q ch output in the Fix Gain Path mode and Variable Gain Path mode.

#### [Specifications]

In 5 MHz sine wave output at a sampling frequency of 200 MHz,

Fix Gain Path mode: < -67 dBc

Variable Gain Path mode: < -61 dBc

#### [Required instruments]

Instrument	Quantity	Recommended model
BNC cable BNC(m)-BNC(m)	1	A01037-1500
Adapter SMA(m)-BNC(f)	2	HRM-517 (09)
Adapter SMA(f)-SMA(f)	1	HRM-501

#### [Connection diagram]

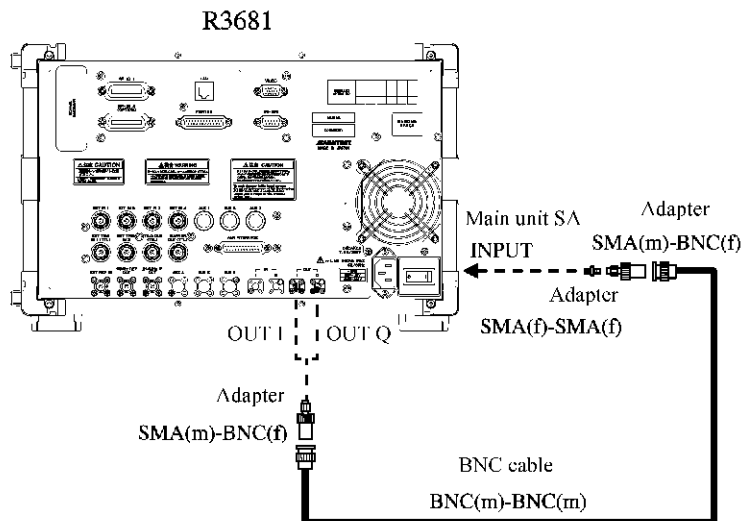

Figure 8-7 SFDR Measurement Connection Diagram

### 8.3.7 SFDR

[Test procedure]

Initialization

1. Preset this instrument.  
Operation: **[Special]→[Preset]→[All]**

Connecting the instruments

2. Connect the instruments as shown in Figure 8-7.

Setting the R3681 series main unit SA

3. Set the center frequency of this instrument to 50 MHz.  
Operation: **{FREQ}, [Center], [5], [0], [M/n]**
4. Set the frequency span to 100 MHz.  
Operation: **{SPAN}, [Span], [1], [0], [0], [M/n]**
5. Set the reference level to 15 dBm.  
Operation: **{LEVEL}, [Ref Level], [1], [5], [ENT]**
6. Set the input attenuator to 35 dB.  
Operation: **[ATT], [3], [5], [ENT]**
7. Set the detection mode to POSITIVE.  
Operation: **{TRACE}, [Trace Detector], [Positive]**
8. Set the resolution bandwidth to 3 kHz.  
Operation: **{BW}, [RBW], [3], [k/μ]**

Setting the AWG option

9. Referring to 8.2, "Loading Waveform Data," load the waveform file SINWV7.
10. Set the I/Q output mode to Fix Gain Path.  
Operation: **[I/Q Output], [I/Q Output], [Fix Gain Path (1V<sub>p-p</sub>)]**
11. After the setting is completed, close the [I/Q Output Control] dialog box.  
Operation: **[I/Q Output Control], [×]**
12. Output the signal.  
Operation: **[AWG ON]**

## Fix Gain Path mode SFDR measurement

13. Make the main unit SA active.  
Operation: [SA↔SG]
14. Set SA to single sweep and have it sweep once.  
Operation: **SINGLE**
15. Carry out peak search.  
Operation: {SEARCH}
16. Set the peak level to be detected to 1 dB.  
Operation: **Peak ΔY**, [1], [ENT]
17. Turn on the Delta MARKER and search for the next peak level.  
Operation: {MKR}, **Delta Marker**, **Next Peak**
18. Read the ΔMARKER value and verify that the value is within the specified range.
19. Turn off all MARKERS.  
Operation: {MKR}, **Marker All Off**
20. Reconnect the AWG output cable to another output channel and repeat steps 14 to 18 to check both the I ch output and the Q ch output.
21. Make AWG active and stop the signal output.  
Operation: [SA↔SG], [AWG ON]

## Variable Gain Path mode SFDR measurement

22. Set the AWG option to 2 V<sub>P-P</sub> output in the Variable Gain Path mode.  
Operation: **I/Q Output**, [Variable Gain Path], [1], **2**, **0**, **0**, **0**, **ENT**
23. After the setting is completed, close the **I/Q Output Control** dialog box.  
Operation: **I/Q Output Control**, [×]
24. Output the signal.  
Operation: [AWG ON]
25. Repeat steps 13 to 19 to check both the I ch output and the Q ch output, the same as in the case of the Fix Gain Path mode.
26. Make AWG active and stop the signal output.  
Operation: [SA↔SG], [AWG ON]

8.3.8 Internal Filter

**8.3.8 Internal Filter**

[Overview]

This section describes the method to verify rough characteristics of the internal filter and switching action by outputting the square wave signal and measuring its rise time.

[Required instruments]

Instrument	Quantity	Recommended model
Oscilloscope	1	TDS5052
BNC cable BNC(m)-BNC(m)	2	A01037-1500
Adapter SMA(m)-BNC(f)	2	HRM-517 (09)

[Connection diagram]

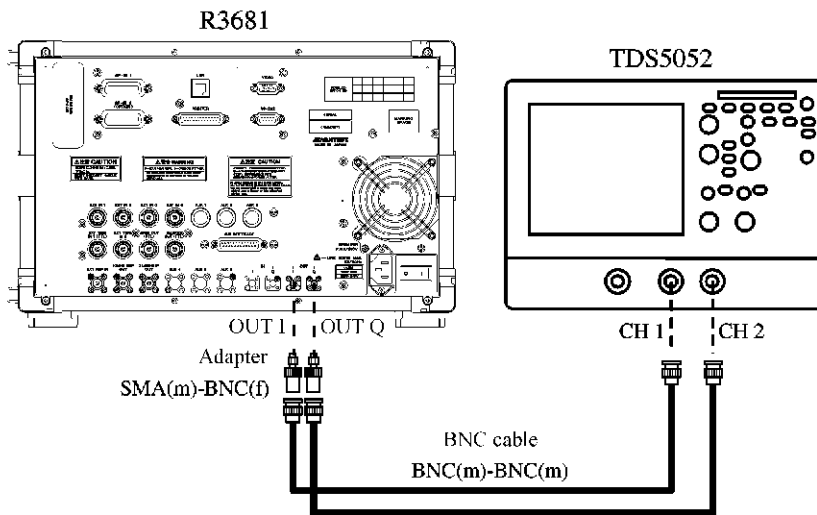

Figure 8-8 Internal Filter Verification Connection Diagram

[Test procedure]

Initialization

1. Preset this instrument.  
Operation: **[Special]**→**[Preset]**→**[All]**

Connecting the instruments

2. Connect the instruments as shown in Figure 8-8.

## Setting the oscilloscope

3. Set the oscilloscope as follows:

Vertical axis	CH1 and CH2
Input coupling:	DC
Scale:	500 mV/div
Input impedance:	50 $\Omega$

Horizontal axis

Sweep:	Table 8-7 horizontal axis setting
--------	-----------------------------------

Trigger

Source:	CH1
Coupling:	DC
Slope:	Positive
Level:	0 V
Mode:	Auto

## Setting the AWG option

4. Referring to 8.2, "Loading Waveform Data," load the waveform file SQWV.
5. Set the I/Q output mode to Fix Gain Path.  
Operation: [**I/Q Output**], [**I/Q Output**], [**Fix Gain Path (1V<sub>p-p</sub>)**]
6. Set the internal filter to Through.  
Operation: [**I/Q Output Filter**], [**Through**]
7. Output the signal.  
Operation: [**AWG ON**]

## Checking the rise time

8. Measure the rise time of the signals of the I ch output and the Q ch output.  
Because the purpose is just to verify the switching action of the internal filter with the difference in the rise time, precise measurement of the rise time is not necessary.
9. Verify that the measured rise time is approximately the same as the value shown in Table 8-7.
10. Stop the signal output.  
Operation: [**AWG ON**]

### 8.3.8 Internal Filter

Verifying other internal filters

11. Verify the rise time of the signal by repeating step 3 and steps 6 to 10 for each filter shown in Table 8-7.

Table 8-7 Internal Filter Verification Setting List

Internal filter	Setting for the horizontal axis of the oscilloscope	Reference value for the rise time
Through	1 ns/div	2 ns
50 MHz	2 ns/div	5 ns
2.5 MHz	40 ns/div	120 ns



### 8.3.9 External Start Trigger

[Overview]

This section describes the method to verify waveform generation by inputting the trigger signal from the outside.

Verify with each of the waveform sequences, continuous, single and gated.

[Required instruments]

Instrument	Quantity	Recommended model
Oscilloscope	1	TDS5052
Pulse generator	1	81110A+81111A
BNC cable BNC(m)-BNC(m)	3	A01037-1500
Adapter SMA(m)-BNC(f)	1	HRM-517 (09)
Adapter BNC T(fm)	1	UG-274/U

[Connection diagram]

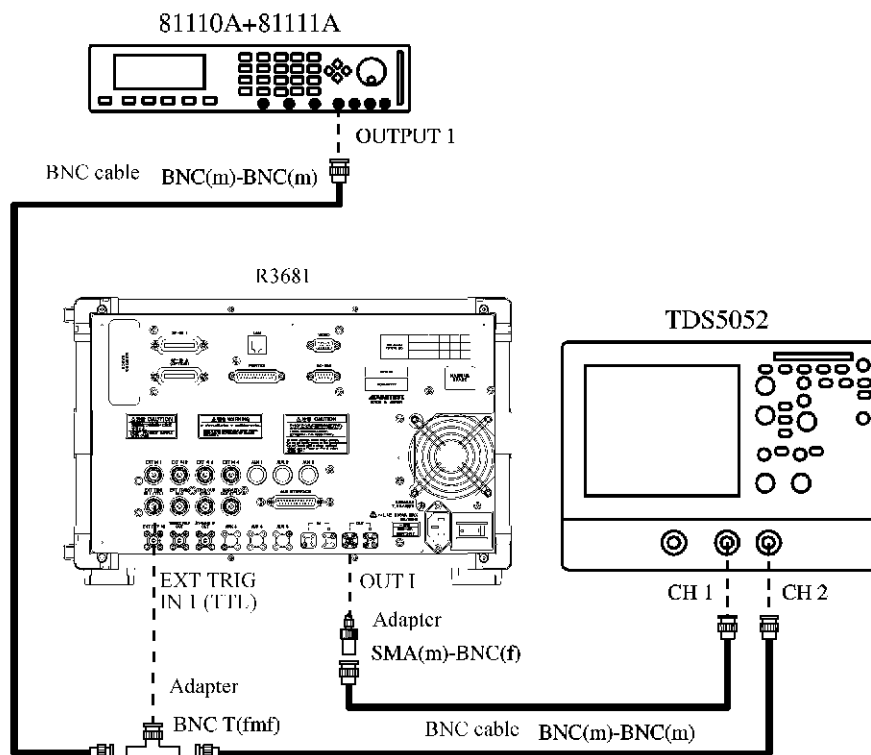

Figure 8-9 External Start Trigger Verification Connection Diagram

### 8.3.9 External Start Trigger

[Test procedure]

Initialization

1. Preset this instrument.  
Operation: **[Special]→[Preset]→[All]**

Connecting the instruments

2. Connect the instruments as shown in Figure 8-9.

Setting the oscilloscope

3. Set the oscilloscope as follows:
 

Vertical axis	CH1 and CH2
Input coupling:	DC
Scale:	CH1; 500 mV/div    CH2; 1 V/div
Input impedance:	CH1; 50 Ω            CH2; 1 MΩ
Horizontal axis	
Sweep:	20 μs/div
Trigger	
Source:	CH2
Coupling:	DC
Slope:	Positive Set Negative only to check the negative trigger polarity for the gated (level).
Level:	2 V
Mode:	Normal

Setting the pulse generator

4. Set the pulse generator as follows:
 

Generation mode:	TRIGGERED PULSES of Double-Pulses
Trigger:	MAN Key
Double delay:	100 μs
Pulse width:	50 μs
Amplitude:	TTL Hi; +2.5 V    TTL Low; 0 V (at 50 Ω)
Polarity:	Normal Set Complement only to check the negative trigger polarity for the gated (level).

## Setting the R3681 series main unit SA

5. Set the sweep mode to synchronized sweep with the external trigger signal (EXT1 terminal).  
Operation: {**SWEEP**}, **Trigger Source**, **Ext1**

## Setting the AWG option

6. Referring to 8.2, "Loading Waveform Data," load the waveform file SINWV3.
7. Set the I/Q output mode to Fix Gain Path.  
Operation: **I/Q Output**, **I/Q Output**, **Fix Gain Path (1V<sub>P-P</sub>)**
8. After the setting is completed, close the **I/Q Output Control** dialog box.  
Operation: **I/Q Output Control**, [×]
9. Set the start trigger to a trigger synchronized with the setting of the main unit SA.  
Operation: **Output Setup**, **Start Trigger**, **Link**

## Verifying continuous

10. Set the waveform generation sequence of AWG to continuous.  
Operation: **Output Setup**, **Output Sequence**, **Continuous**
11. Output the signal from AWG.  
Operation: **AWG ON**
12. Output the signal from the pulse generator to trigger the AWG.
13. Make sure with the oscilloscope that a sine wave signal is output continuously from the rising edge of the trigger signal, as shown in Figure 8-10.
14. Stop the signal output by AWG.  
Operation: **AWG ON**
15. Set the trigger polarity to negative.  
Operation: **Start Trigger**, **Link**, **Negative**
16. Output the signal from AWG.  
Operation: **AWG ON**
17. Output the signal from the pulse generator to trigger the AWG.
18. Make sure with the oscilloscope that a sine wave signal is output continuously from the falling edge of the trigger signal, as shown in Figure 8-11.
19. Stop the signal output by AWG.  
Operation: **AWG ON**

### 8.3.9 External Start Trigger

#### Verifying single

20. Set the waveform generation sequence of AWG to single.  
Operation: **[Output Setup]**, **[Output Sequence]**, **[Single]**
21. Set the trigger polarity to positive.  
Operation: **[Start Trigger]**, **[Link]**, **[Positive]**
22. Output the signal from AWG.  
Operation: **[AWG ON]**
23. Output the signal from the pulse generator to trigger the AWG.
24. Make sure with the oscilloscope that a sine wave signal is output for one period from the rising edge of the trigger signal, as shown in Figure 8-12.
25. Set the trigger polarity to negative.  
Operation: **[Start Trigger]**, **[Link]**, **[Negative]**
26. Output the signal from AWG.  
Operation: **[AWG ON]**
27. Output the signal from the pulse generator to trigger the AWG.
28. Make sure with the oscilloscope that a sine wave signal is output for one period from the falling edge of the trigger signal, as shown in Figure 8-13.
29. Set the number of times of output repetition to three.  
Operation: **[Loop Num]**, **[3]**, **[ENT]**
30. Repeat steps 21 to 28 to conduct verification, even when the number of times of output repetition is three, by setting the trigger polarity to positive and negative.  
For the reference waveform for the oscilloscope, the sine wave signal is output for three periods at the set trigger edge, as shown in Figure 8-14 and Figure 8-15.

#### Verification for gated (edge)

31. Set the waveform generation sequence of AWG to the trigger edge of gated.  
Operation: **[Output Setup]**, **[Output Sequence]**, **[Gated]**, **[Trigger Edge]**
32. Set the trigger polarity to positive.  
Operation: **[Start Trigger]**, **[Link]**, **[Positive]**
33. Output the signal from AWG.  
Operation: **[AWG ON]**
34. Output the signal from the pulse generator to trigger the AWG.
35. Make sure with the oscilloscope that a sine wave signal is output from the rising edge of the trigger signal to the next rising edge, as shown in Figure 8-16.
36. Set the trigger polarity to negative.  
Operation: **[Start Trigger]**, **[Link]**, **[Negative]**

37. Output the signal from AWG.  
Operation: **[AWG ON]**
38. Output the signal from the pulse generator to trigger the AWG.
39. Make sure with the oscilloscope that a sine wave signal is output from the falling edge of the trigger signal to the next falling edge, as shown in Figure 8-17.

#### Verification for gated (level)

40. Set the waveform generation sequence of AWG to the trigger level of gated.  
Operation: **[Output Setup], [Output Sequence], [Gated], [Trigger Level]**
41. Set the trigger polarity to positive.  
Operation: **[Start Trigger], [Link], [Positive]**
42. Output the signal from AWG.  
Operation: **[AWG ON]**
43. Output the signal from the pulse generator to trigger the AWG.
44. Make sure with the oscilloscope that a sine wave signal is output only when the trigger signal is high, as shown in Figure 8-18.
45. Set the trigger slope of the oscilloscope to Negative.
46. Set the polarity of the pulse generator to Complement.
47. Set the trigger polarity of the AWG to Negative.  
Operation: **[Start Trigger], [Link], [Negative]**
48. Output the signal from AWG.  
Operation: **[AWG ON]**
49. Output the signal from the pulse generator to trigger the AWG.
50. Ensure that a sine wave signal is output only when the trigger signal is low by using the oscilloscope as shown in Figure 8-19.

8.3.9 External Start Trigger

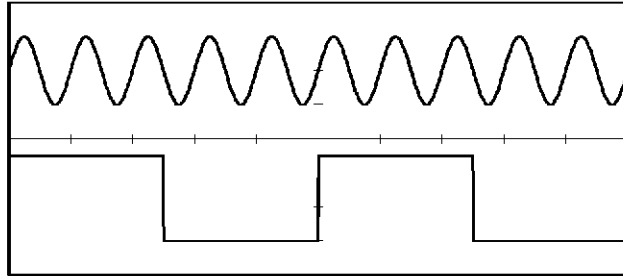

Figure 8-10 Waveform for Continuous, Positive

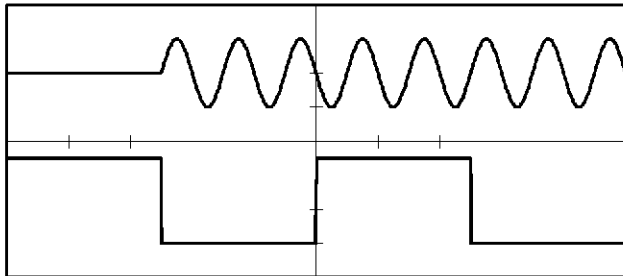

Figure 8-11 Waveform for Continuous, Negative

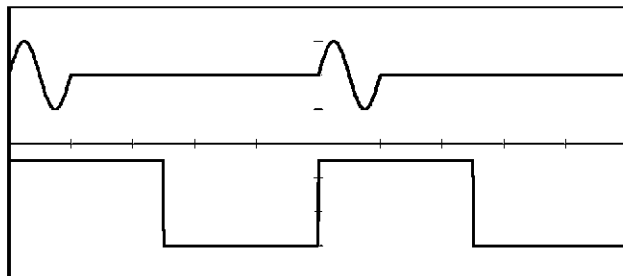

Figure 8-12 Waveform for Single, Once, Positive

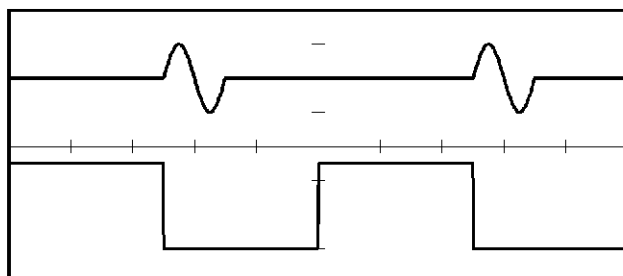

Figure 8-13 Waveform for Single, Once, Negative

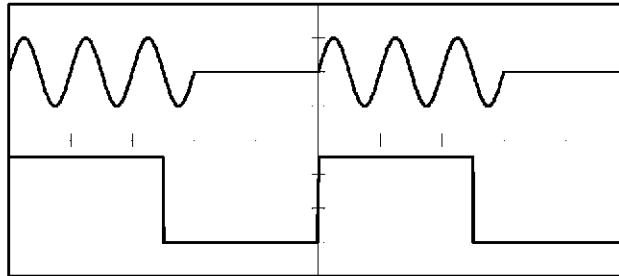

Figure 8-14 Waveform for Single, Three Times, Positive

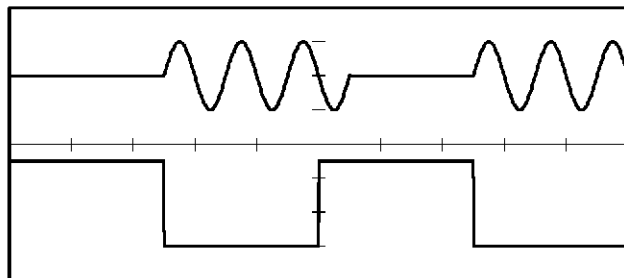

Figure 8-15 Waveform for Single, Three Times, Negative

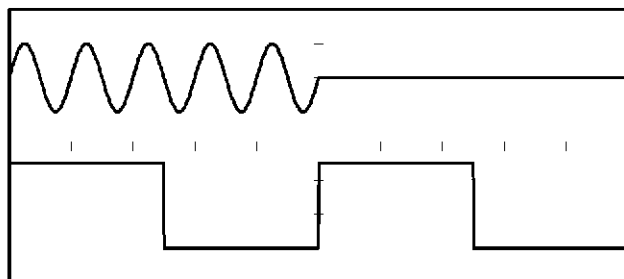

Figure 8-16 Waveform for Gated (edge), Positive

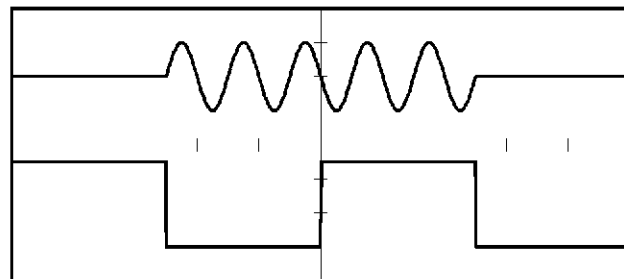

Figure 8-17 Waveform for Gated (edge), Negative

8.3.9 External Start Trigger

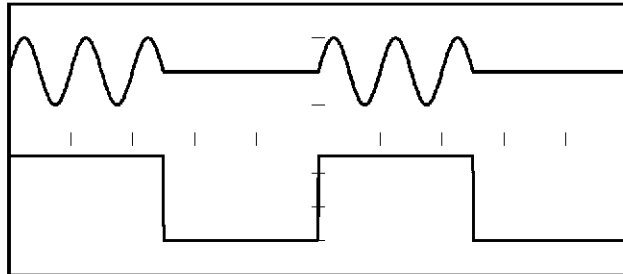

Figure 8-18 Waveform for Gated (level), Positive

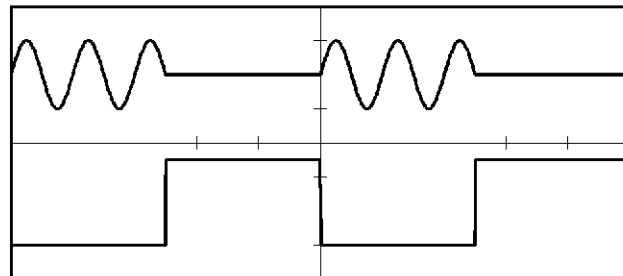

Figure 8-19 Waveform for Gated (level), Negative



### 8.3.10 Marker 1 Output

[Overview]

This section describes the method to verify the output of marker 1.

Marker 1 is only connected directly to the trigger input of the R3681 series main unit SA internally and is not output to the outside.

Verify that the trigger is applied to the main unit SA by setting the trigger source of the main unit SA to marker 1 of the AWG option.

Verify the output of marker 1 for both the sequencer marker mode and the memory marker mode.

[Required instruments]

Instrument	Quantity	Recommended model
BNC cable BNC(m)-BNC(m)	1	A01037-1500
Adapter SMA(m)-BNC(f)	2	HRM-517 (09)
Adapter SMA(f)-SMA(f)	1	HRM-501

[Connection diagram]

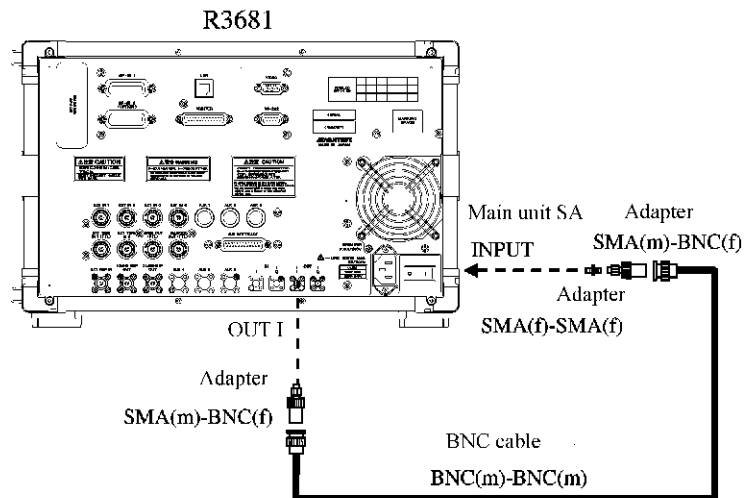

Figure 8-20 Marker 1 Output Verification Connection Diagram

[Test procedure]

Initialization

1. Preset this instrument.  
Operation: **[Special]**→**[Preset]**→**[All]**

### 8.3.10 Marker 1 Output

#### Connecting the instruments

2. Connect the instruments as shown in Figure 8-20.

#### Setting the R3681 series main unit SA

3. Set the center frequency of this instrument to 50 MHz.  
Operation: {FREQ}, **Center**, **5**, **0**, **M/n**
4. Set the frequency span to 1 MHz.  
Operation: {SPAN}, **Span**, **1**, **M/n**
5. Set the sweep mode to synchronized sweep with AWG marker 1.  
Operation: {SWEEP}, **Trigger Source**, **Link**
6. Verify that the sweep by the main unit SA has stopped.

#### Setting the AWG option

7. Referring to 8.2, "Loading Waveform Data," load the waveform file SINWV6.
8. Set the I/Q output mode to Fix Gain Path.  
Operation: **I/Q Output**, **I/Q Output**, **Fix Gain Path (1V<sub>p-p</sub>)**
9. After the setting is completed, close the **I/Q Output Control** dialog box.  
Operation: **I/Q Output Control**, [×]
10. Set the marker 1 output to ON.  
Operation: **Output Setup**, **Marker1**, **ON**
11. After the setting is completed, close the **Output Setup** dialog box.  
Operation: **Output Setup**, [×]

#### Verifying the sequencer marker

12. Set marker generation to the sequencer marker.  
Operation: **Marker Setup**, **Mode**, **Sequencer**
13. Set the length of the high period of the sequencer marker to 40 points.  
Operation: **Marker 1(to SA)**, **High Period**, **4**, **0**, **ENT**, **Apply**
14. Output the signal from AWG.  
Operation: **AWG ON**
15. Verify that the main unit SA starts sweeping and measures the 50 MHz signal.  
(Verification that the marker polarity is positive)

16. Stop the signal output by AWG.  
Operation: **[AWG ON]**
17. Set the polarity of marker 1 to negative.  
Operation: **[Polarity], [Neg], [Apply]**
18. Output the signal from AWG.  
Operation: **[AWG ON]**
19. Verify that the main unit SA sweeps and measures the 50 MHz signal.  
(Verification that the marker polarity is negative)
20. Stop the signal output by AWG.  
Operation: **[AWG ON]**

#### Verifying the memory marker

21. Set marker generation to the memory marker.  
Operation: **[Marker Setup], [Mode], [Memory]**
22. Output the signal from AWG.  
Operation: **[AWG ON]**
23. Verify that the main unit SA starts sweeping and measures the 50 MHz signal.
24. Stop the signal output by AWG.  
Operation: **[AWG ON]**

8.3.11 Marker 2 Output

**8.3.11 Marker 2 Output**

[Overview]

This section describes the method to verify the output of marker 2 using the oscilloscope. Verify the output of marker 2 for both the sequencer marker mode and the memory marker mode.

[Required instruments]

Instrument	Quantity	Recommended model
Oscilloscope	1	TDS5052
BNC cable BNC(m)-BNC(m)	2	A01037-1500
Adapter SMA(m)-BNC(f)	1	HRM-517 (09)

[Connection diagram]

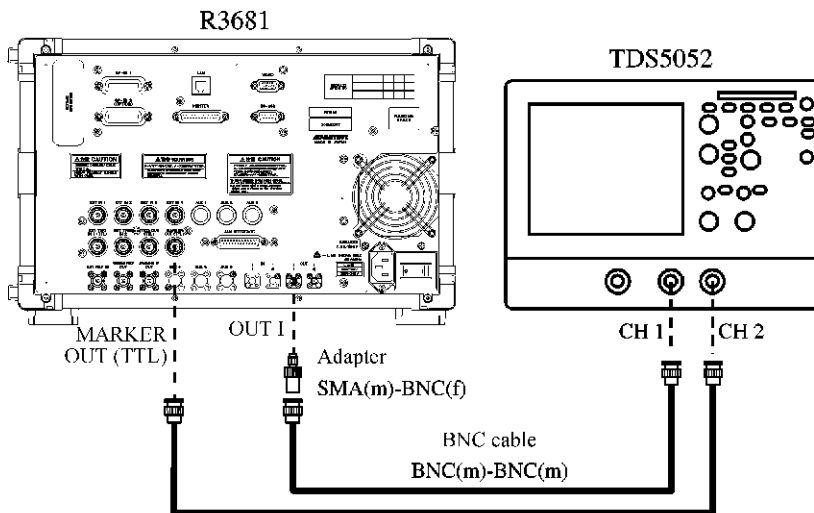

Figure 8-21 Marker 2 Output Verification Connection Diagram

[Test procedure]

Initialization

1. Preset this instrument.  
Operation: **[Special]**→**[Preset]**→**[All]**

Connecting the instruments

2. Connect the instruments as shown in Figure 8-21.

## Setting the oscilloscope

3. Set the oscilloscope as follows:

Vertical axis	CH1 and CH2
Input coupling:	DC
Scale:	CH1; 500 mV/div CH2; 2 V/div
Input impedance:	1 M $\Omega$
Horizontal axis	
Sweep:	20 $\mu$ s/div
Trigger	
Source:	CH1
Coupling:	DC
Slope:	Positive
Level:	0 V
Mode:	Auto

## Setting the AWG option

4. Referring to 8.2, "Loading Waveform Data," load the waveform file SINWV1.
5. Set the I/Q output mode to Fix Gain Path.  
Operation: **I/Q Output**, [**I/Q Output**], [**Fix Gain Path (1V<sub>p-p</sub>)**]
6. After the setting is completed, close the [**I/Q Output Control**] dialog box.  
Operation: [**I/Q Output Control**], [X]
7. Set the marker 2 output to ON.  
Operation: **Output Setup**, [**Marker2**], [**ON**]
8. After the setting is completed, close the [**Output Setup**] dialog box.  
Operation: [**Output Setup**], [X]

## Verifying the sequencer marker

9. Set marker generation to the sequencer marker.  
Operation: **Marker Setup**, [**Mode**], [**Sequencer**]
10. Set the length of the high period of the sequencer marker to 10,000 points.  
Operation: [**Marker2 (to Rear Marker Output)**], [**High Period**], **1**, **0**, **0**, **0**, **0**, **0**, **0**, **ENT**
11. Set the length of the low period of the sequencer marker to 10,000 points.  
Operation: [**Low Period**], **1**, **0**, **0**, **0**, **0**, **0**, **0**, **ENT**
12. Reflect the details of the setting for marker 2.  
Operation: [**Apply**]

### 8.3.11 Marker 2 Output

13. Output the signal from AWG.  
Operation: **[AWG ON]**
14. Verify that the marker that is high in the period in which the output signal is positive outputs as shown in Figure 8-22.  
(Verification that the marker polarity is positive)
15. Stop the signal output.  
Operation: **[AWG ON]**
16. Set the polarity of marker 2 to negative.  
Operation: **[Polarity], [Neg], [Apply]**
17. Output the signal.  
Operation: **[AWG ON]**
18. Verify that the marker that is high in the period in which the output signal is negative outputs as shown in Figure 8-23.  
(Verification that the marker polarity is negative)
19. Stop the signal output.  
Operation: **[AWG ON]**

#### Verifying the memory marker

20. Set marker generation to the memory marker.  
Operation: **[Marker Setup], [Mode], [Memory]**
21. Output the signal from AWG.  
Operation: **[AWG ON]**
22. Verify that the marker that repeats high and low for every 1/4 period of the output signal outputs as shown in Figure 8-24.
23. Stop the signal output.  
Operation: **[AWG ON]**

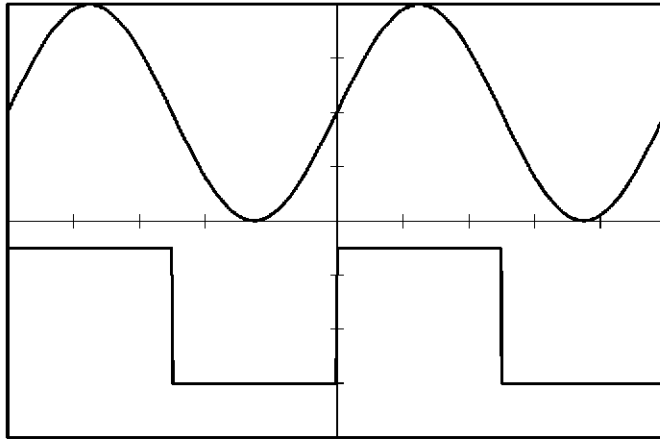

Figure 8-22 Reference Waveform for Sequence Marker, Positive

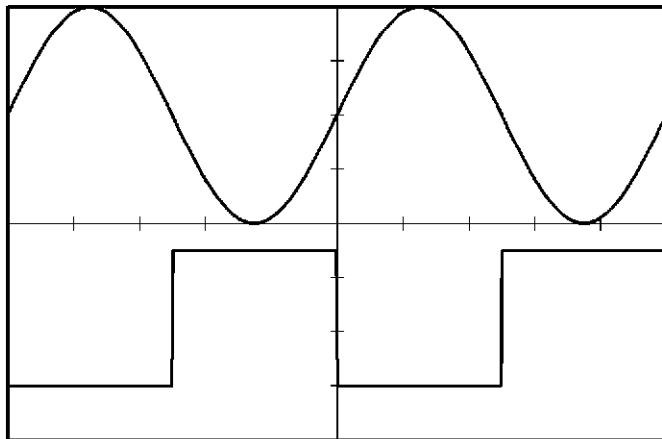

Figure 8-23 Reference Waveform for Sequence Marker, Negative

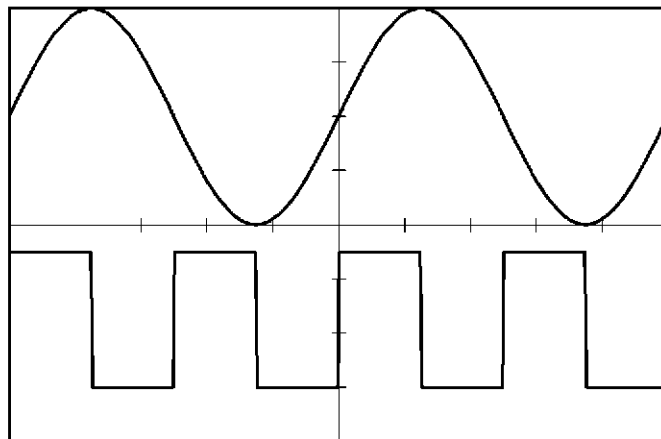

Figure 8-24 Reference Waveform for Memory Marker

8.3.12 Bit Error Rate Counter

**8.3.12 Bit Error Rate Counter**

[Overview]

This section describes the method to verify the bit error rate measuring function.

Verify that the bit error rate can be measured by inputting the I ch output of the clock signal and the Q ch output of the data signal to the bit error rate counter.

[Required instruments]

Instrument	Quantity	Recommended model
BNC cable BNC(m)-BNC(m)	2	A01037-1500
Adapter SMA(m)-BNC(f)	2	HRM-517 (09)

[Connection diagram]

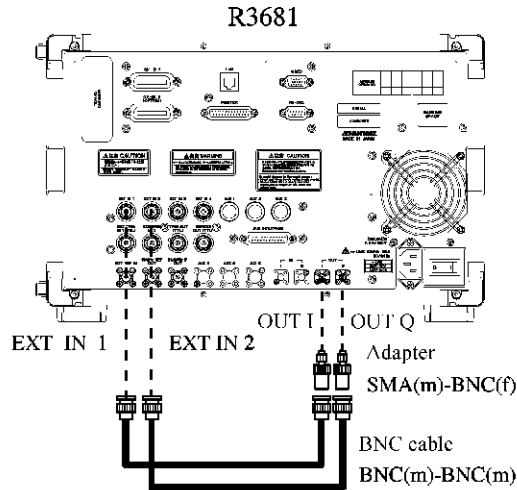

Figure 8-25 Bit Error Rate Counter Verification Connection Diagram

[Test procedure]

Initialization

1. Preset this instrument.  
Operation: **[Special]**→**[Preset]**→**[All]**

Connecting the instruments

2. Connect the instruments as shown in Figure 8-25.



## Setting the AWG option

3. Referring to 8.2, "Loading Waveform Data," set the waveform storing memory split mode to the  $32M \times 2$  waveform mode and load waveform file BER1 to Wave1 and waveform file BER2 to Wave2.
4. Set the I/Q output to 1.5 V<sub>p-p</sub> output in the Variable Gain Path mode.  
Operation: **I/Q Output**, [**I/Q Output**], [**Variable Gain Path**], [**I**], [**1**], [**5**], [**0**], [**0**], [**ENT**]
5. Set the DC offset to 750 mV.  
Operation: [**I/Q Offset**], [**I**], [**7**], [**5**], [**0**], [**ENT**]
6. After the setting is completed, close the [**I/Q Output Control**] dialog box.  
Operation: [**I/Q Output Control**], [**×**]
7. Set the sampling frequency to 120 MHz.  
Operation: **Output Setup**, [**Sampling Freq**], [**1**], [**2**], [**0**], [**M/n**]
8. Set the output waveform to Wave1.  
Operation: [**Output Waveform Select**], [**Wave1**]
9. After the setting is completed, close the [**Output Setup**] dialog box.  
Operation: [**Output Setup**], [**×**]
10. Output the signal from AWG.  
Operation: [**AWG ON**]

## Measuring bit error rate

11. Set the measuring length for the bit error rate measurement to 4,088 bits.  
Operation: {**BER**}, **Measure Bit Length**, [**4**], [**0**], [**8**], [**8**], [**ENT**]
12. Measure the bit error rate.  
Operation: [**SINGLE**]
13. Verify that the measurement results of the bit error rate are as follows:  
(Verification when data polarity is positive and the clock slope is at the rising edge)

Bit Error Rate:	0.0%
Error Bits:	0 bits
Total Bits:	4088 bits
Cycle Count:	1
Measure Bit Length:	4088 bits
14. Stop the signal output by AWG.  
Operation: {**AWG**}, [**AWG ON**]

### 8.3.12 Bit Error Rate Counter

15. Set the output waveform of AWG to Wave2.  
Operation: **Output Setup**, **Output Waveform Select**, **Wave2**
16. After the setting is completed, close the **Output Setup** dialog box.  
Operation: **Output Setup**, [×]
17. Output the signal from AWG.  
Operation: **AWG ON**
18. Set the data polarity of the bit error rate measurement to Negative.  
Operation: {BER}, **Measure Setup**, **Data Polarity**, **Negative**
19. Set the clock signal to the falling edge.  
Operation: **Clock Slope**, **Falling**
20. After the setting is completed, close the **Bit Error Rate Counter Setup** dialog box.  
Operation: **Bit Error Rate Counter Setup**, [×]
21. Measure the bit error rate.  
Operation: **SINGLE**
22. Verify that the measurement results of the bit error rate are as follows:  
(Verification when data polarity is negative and the clock slope is at the falling edge)

Bit Error Rate:	3.1%
Error Bits:	128 bits
Total Bits:	4088 bits
Cycle Count:	1
Measure Bit Length:	4088 bits
23. Stop the signal output by AWG.  
Operation: {AWG}, **AWG ON**

## 8.4 AWG Performance Verification Record Sheets

### 8.4.1 Signal Output

Waveform storing memory split mode	Output waveform	Measured value [ $\mu$ s]	Reference value [ $\mu$ s]	Pass/Fail
64M $\times$ 1 waveform	Wave 1		100	
32M $\times$ 2 waveform	Wave 1		100	
	Wave 2		50	
16M $\times$ 4 waveform	Wave 1		100	
	Wave 2		50	
	Wave 3		20	
	Wave 4		10	

### 8.4.2 Output Amplitude

Fix Gain Path

Item	Specification (Min.)	Measured value	Specification (Max.)	Pass/Fail
Fix level I	700.1 mV	mV	714.1 mV	
Fix level Q	700.1 mV	mV	714.1 mV	
Fix level error between channels	-0.2%	%	+0.2%	

8.4.3 Residual DC Offset

Variable Gain Path

Item	Specification (Min.)	Measured value	Specification (Max.)	Pass/Fail
Var 200 mV level I	138.6 mV	mV	144.2 mV	
Var 200 mV level Q	138.6 mV	mV	144.2 mV	
Val 200 mV level error between channels	-1.0%	%	+1.0%	
Var 1 V level I	693.0 mV	mV	721.2 mV	
Var 1 V level Q	693.0 mV	mV	721.2 mV	
Val 1 V level error between channels	-1.0%	%	+1.0%	
Var 2 V level I	1,386 mV	mV	1,442 mV	
Var 2 V level Q	1,386 mV	mV	1,442 mV	
Var 2 V level error between channels	-1.0%	%	+1.0%	

8.4.3 Residual DC Offset

Measured item	Specification (Min.) [mV]	Measured value [mV]	Specification (Max.) [mV]	Pass/Fail
Fix Gain Path Ich	-1.0		+1.0	
Fix Gain Path Qch	-1.0		+1.0	
Variable Gain Path Ich	-2.0		+2.0	
Variable Gain Path Qch	-2.0		+2.0	

8.4.4 DC Offset

Set value [mV]	Specification (Min.) [mV]	Measured value [mV]	Specification (Max.) [mV]	Pass/Fail
750	1,485		1,515	
-750	-1,485		-1,515	

**8.4.5 Sampling Frequency**

Sampling frequency set value [MHz]	Specification (Min.) [MHz]	Output signal frequency measured value [MHz]	Specification (Max.) [MHz]	Pass/Fail
200	49.99999999		50.00000001	
100	24.99999999		25.00000001	
12.5	3.12499999		3.12500001	

**8.4.6 Phase Difference between Channels**

Measured value [ns]	Specification (Max.) [ns]	Pass/Fail
	2	

**8.4.7 SFDR**

Output mode	Output CH	Measured value [dBc]	Specification (Max.) [dBc]	Pass/Fail
Fix Gain Path	Ich		-67	
	Qch		-67	
Variable Gain Path	Ich		-61	
	Qch		-61	

**8.4.8 Internal Filter**

Internal filter	Output CH	Measured value [ns]	Reference value [ns]	Pass/Fail
Through	Ich		2	
	Qch		2	
50 MHz	Ich		5	
	Qch		5	
2.5 MHz	Ich		120	
	Qch		120	

8.4.9 External Start Trigger

**8.4.9 External Start Trigger**

Waveform generation sequence	Trigger polarity	Reference waveform	Pass/Fail
Continuous	Positive	Figure 8-10	
	Negative	Figure 8-11	
Single Repetition: Once	Positive	Figure 8-12	
	Negative	Figure 8-13	
Single Repetition: Three times	Positive	Figure 8-14	
	Negative	Figure 8-15	
Gated (Edge)	Positive	Figure 8-16	
	Negative	Figure 8-17	
Gated (Level)	Positive	Figure 8-18	
	Negative	Figure 8-19	

**8.4.10 Marker 1 Output**

Marker mode	Pass/Fail
Sequencer marker (Pos)	
Sequencer marker (Neg)	
Memory marker	

**8.4.11 Marker 2 Output**

Marker mode	Reference waveform	Pass/Fail
Sequencer marker (Pos)	Figure 8-22	
Sequencer marker (Neg)	Figure 8-23	
Memory marker	Figure 8-24	

**8.4.12 Bit Error Rate Counter**

Setting	Measured item	Measured value	Reference value	Pass/Fail
Data: Positive Clock: Rising	Bit Error Rate	%	0.0%	
	Error Bits	bits	0 bits	
	Total Bits	bits	4088 bits	
	Cycle Count		1	
	Measure Bit Length	bits	4088 bits	
Data: Negative Clock: Falling	Bit Error Rate	%	3.1%	
	Error Bits	bits	128 bits	
	Total Bits	bits	4088 bits	
	Cycle Count		1	
	Measure Bit Length	bits	4088 bits	

8.5 SG Performance Verification Procedure

8.5 SG Performance Verification Procedure

This section describes the performance verification procedure in order of the items listed in Table 8-2.

8.5.1 Frequency Accuracy

[Overview]

In this section, verify that the frequency of the output signal synchronizes with the internal reference signal source by using the frequency counter function of the SA.

[Specifications]

Range: 50 MHz to 6 GHz (R3681)  
50 MHz to 3 GHz (R3671)

Accuracy: Depending on the reference signal source accuracy

[Required instruments]

Product	Quantity	Recommended model
RF cable K(m)-K(m)	1	SF102
Adapter K(f)-K(f)	1	5A-SFF40(A)
Adapter N(m)-SMA(f)	1	HRM-554S

[Connection diagram]

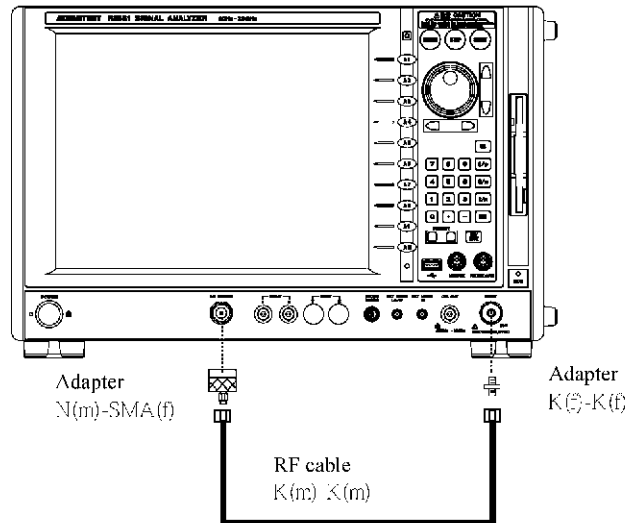

Figure 8-26 Connection Diagram for the Frequency Accuracy Verification



## [Test procedure]

## Initialization

1. Preset this instrument.  
Operation: **[Special]→[Preset]→[All]**

## Connection

2. Connect the instruments as shown in Figure 8-26.

## Option selection

3. Select the SG+AWG option.  
Operation: **[Config]→[SG+AWG Option]**

## SG setting

4. Set the frequency to 50 MHz.  
Operation: **{FREQ}, Frequency, 5, 0, M/n**
5. Set the level to 0 dBm.  
Operation: **{AMPL}, Amplitude, 0, ENT**
6. Set the RF output to ON.  
Operation: **[RF OUT ON]**

## Measurement by using the SA function

7. Activate the SA.  
Operation: **[SA↔SG]**
8. Set the center frequency to 50 MHz.  
Operation: **{FREQ}, Center, 5, 0, M/n**
9. Set the frequency span to 10 MHz.  
Operation: **{SPAN}, Span, 1, 0, M/n**
10. Set the marker on the waveform by using the marker search function.  
Operation: **{SERCH}**
11. Measure the frequency by using the counter function.  
Operation: **{MENU2}, {MEAS}, Counter**
12. Verify that the measured frequency accuracy is within  $\pm 1$  Hz.

### 8.5.1 Frequency Accuracy

13. Activate the SG option.  
Operation: **[SA↔SG]**
14. Repeat steps 7 to 13 by changing the frequency according to the performance verification record sheet (8.6.1).

## 8.5.2 Level Accuracy

### [Overview]

This section describes how to verify the output signal level accuracy by using the power meter.

### [Specifications]

Range: Modulation ON -15 dBm to +13 dBm  
 Modulation OFF -15 dBm to +10 dBm

Accuracy:  $\pm 1.5$  dB

---

**CAUTION:** *The dedicated calibration system is needed to verify the specifications outside the above range. Please contact the nearest ADVANTEST office listed at the end of this Operation Manual or ADVANTEST's sales representatives.*

---

### [Required instruments]

Product	Quantity	Recommended model
Power meter	1	NRVS
Power sensor	1	NRV-Z55

### [Connection diagram]

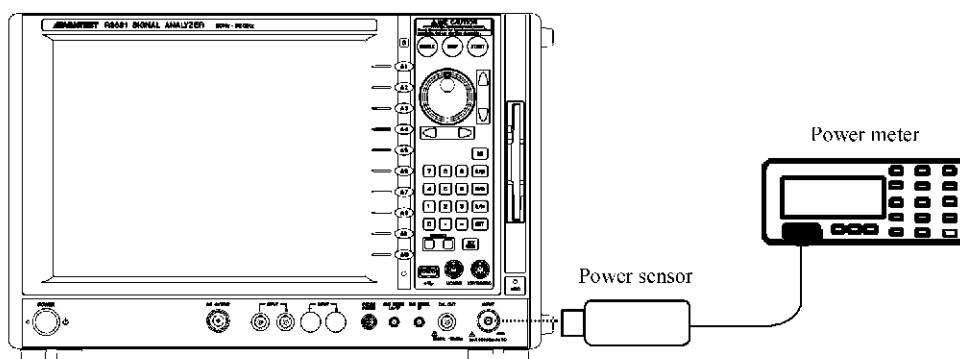

Figure 8-27 Level Accuracy Verification Connection Diagram

### [Test procedure]

#### Initialization

1. Preset this instrument.  
 Operation: **[Special]**→**[Preset]**→**[All]**

---

## 8.5.2 Level Accuracy

### Connection

2. Connect the instruments as shown in Figure 8-27.

---

**MEMO** Use the power meter after performing the zero point adjustment and calibration.

---

### Option selection

3. Select the SG+AWG option.  
Operation: [Config]→[SG+AWG Option]

### Level measurement when the modulation is OFF

4. Set the frequency to 50 MHz.  
Operation: {FREQ}, [Frequency], [5], [0], [M/n]
5. Set the level to 13 dBm.  
Operation: {AMPL}, [Amplitude], [1], [3], [ENT]
6. Set the RF output to ON.  
Operation: [RF OUT ON]
7. Verify that the measured output signal level is within the specifications by using the power meter, by changing the frequency and level according to the performance verification record sheet (8.6.2).

### AWG setting

8. Referring to 8.2, "Loading Waveform Data," load the waveform file "3GPP\_TM1\_64\_1."
9. Set the I/Q output mode to Fix Gain Path.  
Operation: [I/Q Output], [I/Q Output], [Fix Gain Path(1V<sub>p-p</sub>)]
10. After the setting is complete, close the [I/Q Output Control] dialog box.
11. Output the AWG signal.  
Operation: [AWG ON]

Level measurement when the modulation is ON

12. Set the frequency to 50 MHz.

Operation: {**FREQ**}, **Frequency**, **5**, **0**, **M/n**

13. Set the level to 13 dBm.

Operation: {**AMPL**}, **Amplitude**, **1**, **0**, **ENT**

14. Set the RF output to ON.

Operation: **[RF OUT ON]**

15. Sets the modulation to ON.

Operation: **[MOD ON]**

16. Verify that the measured output signal level is within the specifications by using the power meter, by changing the frequency and level according to the performance verification record sheet (8.6.2).

8.5.3 Attenuator Hold Level Variable Range

### 8.5.3 Attenuator Hold Level Variable Range

[Overview]

This section describes how to verify the level valuable range, which is varied by ALC, by using the power meter when the programmable attenuator hold mode is set to On.

[Specifications]

Range: >10 dB<sub>P-P</sub>

[Required instruments]

Product	Quantity	Recommended model
Power meter	1	NRVS
Power sensor	1	NRV-Z55

[Connection diagram]

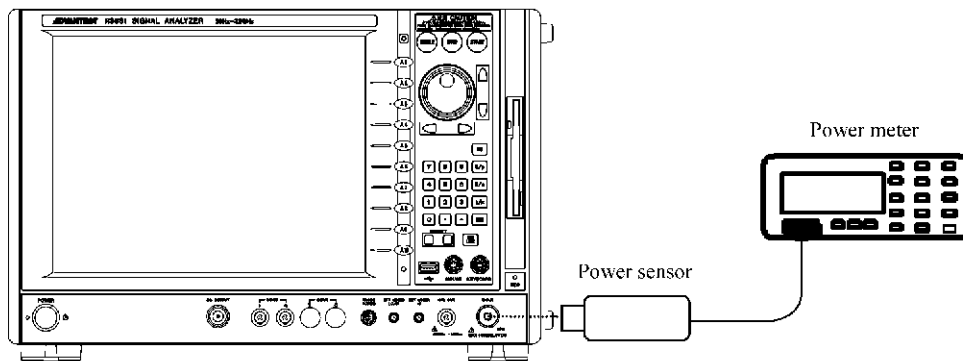

Figure 8-28 Verification Connection Diagram of the Attenuator Hold Level Variable Range

[Test procedure]

Initialization

1. Preset this instrument.  
Operation: **[Special]**→**[Preset]**→**[All]**

Connection

2. Connect the instruments as shown in Figure 8-28.

**MEMO** Use the power meter after performing the zero point adjustment and calibration.

## Option selection

3. Select the SG+AWG option.  
Operation: [Config]→[SG+AWG Option]

## SG setting and level measurement

4. Set the frequency to 50 MHz.  
Operation: {FREQ}, **Frequency**, **5**, **0**, **M/n**
5. Set the level to 0 dBm.  
Operation: {AMPL}, **Amplitude**, **0**, **ENT**
6. Set the RF output to ON.  
Operation: **RF OUT ON**
7. Set the attenuator hold mode to On.  
Operation: {AMPL}, **ATT Hold** (On)
8. Verify by using the power meter that the specified level valuable range is kept, by changing the level setting more than  $\pm 5$  dB.
9. Set the attenuator hold mode to Off.  
Operation: {AMPL}, **ATT Hold** (Off)
10. Repeat steps 4 to 9 by changing the frequency according to the performance verification record sheet (8.6.3).

8.5.4 ALC Hold ADJ Accuracy

**8.5.4 ALC Hold ADJ Accuracy**

[Overview]

This section describes how to verify the level accuracy, which is secured by the ALC hold voltage readjustment function, by using the power meter.

[Specifications]

Range: >0.25 dB

[Required instruments]

Product	Quantity	Recommended model
Power meter	1	NRVS
Power sensor	1	NRV-Z55

[Connection diagram]

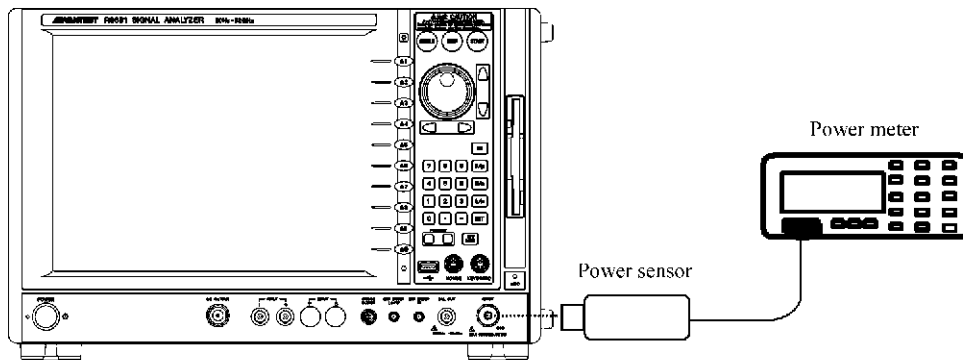

Figure 8-29 Verification Connection Diagram of the ALC Hold ADJ Accuracy

[Test procedure]

Initialization

1. Preset this instrument.  
Operation: [Special]→[Preset]→[All]

Connection

2. Connect the instruments as shown in Figure 8-29.

---

**MEMO** Use the power meter after performing the zero point adjustment and calibration.

---



## Option selection

3. Select the SG+AWG option.  
Operation: [Config]→[SG+AWG Option]

## SG setting and level measurement

4. Set the frequency to 50 MHz.  
Operation: {FREQ}, **Frequency**, **5**, **0**, **M/n**
5. Set the level to 0 dBm.  
Operation: {AMPL}, **Amplitude**, **0**, **ENT**
6. Set the RF output to ON.  
Operation: **[RF OUT ON]**
7. Set the value measured by the power meter as the reference level.
8. Set ALC to the hold mode.  
Operation: {AMPL}, **More 2/2**, **ALC Mode**, **Hold**
9. Readjust the ALC hold voltage.  
Operation: {AMPL}, **More 2/2**, **ALC Hold Adj**
10. Verify that the difference between the level measured by the power meter and the reference level, which is set in step 7, is within the specification.
11. Set ALC to the normal mode.  
Operation: {AMPL}, **More 2/2**, **ALC Mode**, **Normal**
12. Repeat steps 4 to 11 by changing the frequency according to the performance verification record sheet (8.6.4).

8.5.5 SSB Phase Noise

**8.5.5 SSB Phase Noise**

[Overview]

This section describes how to verify the SSB phase noise of the output signal by using the SA function.

[Specifications]

(20 kHz offset)

50 MHz ≤ f ≤ 500 MHz: <-115 dBc/Hz

4 GHz < f ≤ 6 GHz: <-115 dBc/Hz

[Required instruments]

Product	Quantity		Recommended model
	R3681	R3671	
RF cable K(m)-K(m)	1	0	SF102
Adapter K(f)-K(f)	1	0	5A-SFF40(A)
Adapter N(m)-SMA(f)	1	0	HRM-554S
RF cable BNC(m)-BNC(m)	0	1	A01037-1500
Adapter N(m)-BNC(f)	0	2	JUG-201A/U

[Connection diagram]

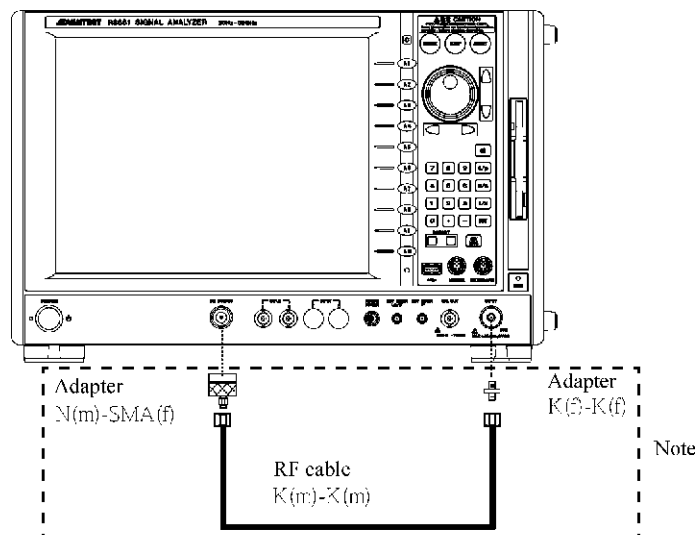

Figure 8-30 SSB Phase Noise Verification Connection Diagram

## [Test procedure]

## Initialization

1. Preset this instrument.  
Operation: **[Special]→[Preset]→[All]**

## Connection

2. Connect the instrument as shown in Figure 8-30.

## Option selection

3. Select the SG+AWG option.  
Operation: **[Config]→[SG+AWG Option]**

## SG setting

4. Set the frequency to 500 MHz.  
Operation: **{FREQ}, Frequency, 5, 0, 0, M/n**
5. Set the level to 0 dBm.  
Operation: **{AMPL}, Amplitude, 0, ENT**
6. Set the RF output to ON.  
Operation: **[RF OUT ON]**

## Measurement by using the SA function

7. Activate the SA.  
Operation: **[SA↔SG]**
8. Set the center frequency to 500 MHz.  
Operation: **{FREQ}, Center, 5, 0, 0, M/n**
9. Set the frequency span to 100 kHz.  
Operation: **{SPAN}, Span, 1, 0, 0, k/μ**
10. Set the VBW to 30 Hz.  
Operation: **{BW}, VBW, 3, 0, ENT**
11. Set the marker on the waveform by using the marker search function.  
Operation: **{SERCH}**
12. Execute Peak→Ref.  
Operation: **{MKR→}, Peak→Ref**

### 8.5.5 SSB Phase Noise

13. Verify that the phase noise at the offset 20 kHz, which is measured by using the dBc/Hz function, is within the specification.

Operation: {MENU2}, {MEAS}, **Noise/Hz**, **dBc/Hz**, **2**, **0**, **k/μ**

14. Activate the SG option.

Operation: [SA↔SG]

15. Repeat steps 4 to 14 by changing the frequency according to the performance verification record sheet (8.6.5).

## 8.5.6 Broadband Noise

[Overview]

This section describes how to verify the broadband noise of the output signal by using the SA function.

[Specifications]

<-132 dBc/Hz (When 2 GHz and 0 dBm is output)

[Required instruments]

Product	Quantity		Recommended model
	R3681	R3671	
RF cable K(m)-K(m)	1	0	SF102
Adapter K(f)-K(f)	1	0	5A-SFF40(A)
Adapter N(m)-SMA(f)	1	0	HRM-554S
RF cable BNC(m)-BNC(m)	0	1	A01037-1500
Adapter N(m)-BNC(f)	0	2	JUG-201A/U

[Connection diagram]

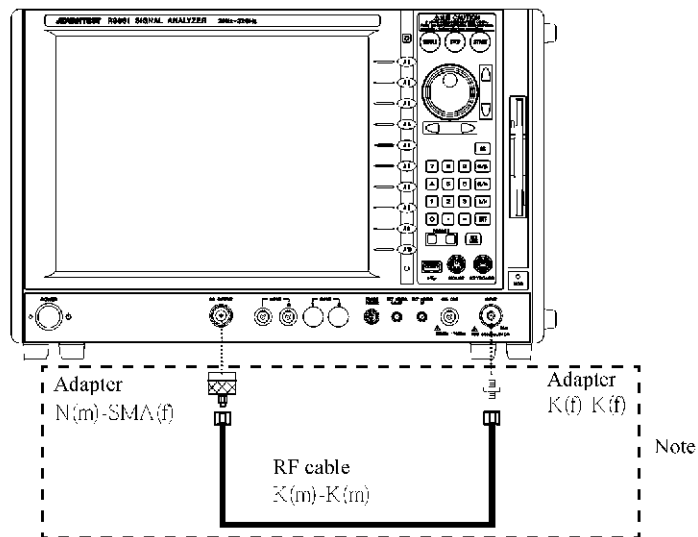

Note: The R3671 uses the N(m)-BNC(f) adapter and the BNC(m)-BNC(m) cable.

Figure 8-31 Broadband Noise Verification Connection Diagram

8.5.6 Broadband Noise

[Test procedure]

Initialization

1. Preset this instrument.  
Operation: **[Special]→[Preset]→[All]**

Connection

2. Connect the instrument as shown in Figure 8-31.

Option selection

3. Select the SG+AWG option.  
Operation: **[Config]→[SG+AWG Option]**

SG setting

4. Set the frequency to 2 GHz.  
Operation: {**FREQ**}, **Frequency**, **2**, **G/p**
5. Set the level to 0 dBm.  
Operation: {**AMPL**}, **Amplitude**, **0**, **ENT**
6. Set the RF output to ON.  
Operation: **[RF OUT ON]**

Measurement by using the SA function

7. Activate the SA.  
Operation: **[SA↔SG]**
8. Set the center frequency to 2 GHz.  
Operation: {**FREQ**}, **Center**, **2**, **G/p**
9. Set the frequency span to 100 MHz.  
Operation: {**SPAN**}, **Span**, **1**, **0**, **0**, **M/n**
10. Set the VBW to 3 kHz.  
Operation: {**BW**}, **VBW**, **3**, **k/μ**
11. Set the marker on the waveform by using the marker search function.  
Operation: {**SERCH**}
12. Execute Peak→Ref.  
Operation: {**MKR→**}, **Peak→Ref**

13. Verify that the noise, which is measured by using the Noise/Hz function, is within the specification.

Operation: {MENU2}, {MEAS}, Noise/Hz, dBc/Hz, 2, 0, M/n

14. Activate the SG option.

Operation: [SA↔SG]

8.5.7 Harmonics

8.5.7 Harmonics

[Overview]

This section describes how to verify the harmonics of the output signal by using the SA function.

[Specifications]

<-30 dBc (When +10 dBm is output)

[Required instruments]

Product	Quantity		Recommended model
	R3681	R3671	
RF cable K(m)-K(m)	1	0	SF102
Adapter K(f)-K(f)	1	0	5A-SFF40(A)
Adapter N(m)-SMA(f)	1	0	HRM-554S
RF cable BNC(m)-BNC(m)	0	1	A01037-1500
Adapter N(m)-BNC(f)	0	2	JUG-201A/U

[Connection diagram]

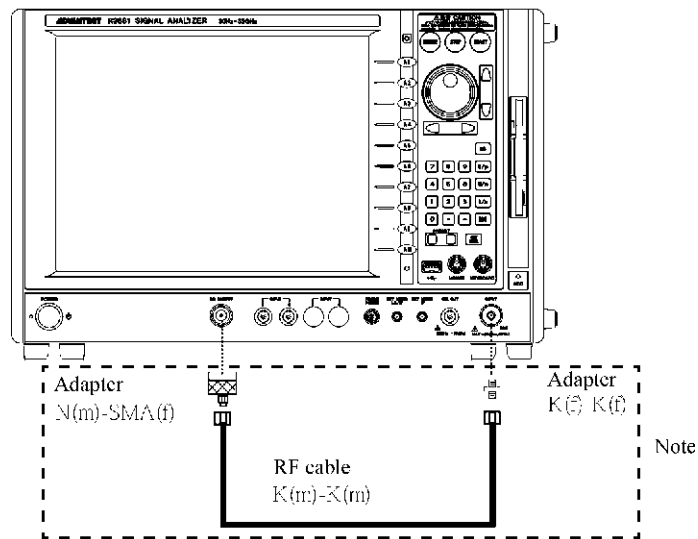

Note: The R3671 uses the N(m)-BNC(f) adapter and the BNC(m)-BNC(m) cable.

Figure 8-32 Harmonics Verification Connection Diagram



## [Test procedure]

## Initialization

1. Preset this instrument.  
Operation: **[Special]→[Preset]→[All]**

## Connection

2. Connect the instrument as shown in Figure 8-32.

## Option selection

3. Select the SG+AWG option.  
Operation: **[Config]→[SG+AWG Option]**

## SG setting

4. Set the frequency to 50 MHz.  
Operation: **{FREQ}, Frequency, 5, 0, M/n**
5. Set the level to +10 dBm.  
Operation: **{AMPL}, Amplitude, 1, 0, ENT**
6. Set the RF output to ON.  
Operation: **[RF OUT ON]**

## Measurement by using the SA function

7. Activate the SA.  
Operation: **[SA↔SG]**
8. Set the center frequency to 50 MHz.  
Operation: **{FREQ}, Center, 5, 0, M/n**
9. Set the frequency span to 1 MHz.  
Operation: **{SPAN}, Span, 1, M/n**
10. Set the reference level to +10 dBm.  
Operation: **{LEVEL}, Ref Level, 1, 0, ENT**
11. Set the marker on the waveform by using the marker search function.  
Operation: **{SERCH}**
12. Set the value on the marker as the fundamental wave level.

8.5.7 Harmonics

13. Set the center frequency to the double frequency of the fundamental wave.

Operation: {**FREQ**}, **Center**, **1**, **0**, **0**, **M/n**

14. Set the marker on the waveform by using the marker search function.

Operation: {**SERCH**}

15. Verify that the difference between the marker level and the fundamental wave level, which is set in step 12, is within the specification.

16. Activate the SG option.

Operation: [**SA**↔**SG**]

17. Repeat steps 4 to 16 by changing the frequency according to the performance verification record sheet (8.6.7).

### 8.5.8 Non-harmonics

[Overview]

This section describes how to verify the non-harmonics of the output signal by using the SA function.

[Specifications]

<-65 dBc (When 0 dBm is output)

[Required instruments]

Product	Quantity		Recommended model
	R3681	R3671	
RF cable K(m)-K(m)	1	0	SF102
Adapter K(f)-K(f)	1	0	5A-SFF40(A)
Adapter N(m)-SMA(f)	1	0	HRM-554S
RF cable BNC(m)-BNC(m)	0	1	A01037-1500
Adapter N(m)-BNC(f)	0	2	JUG-201A/U

[Connection diagram]

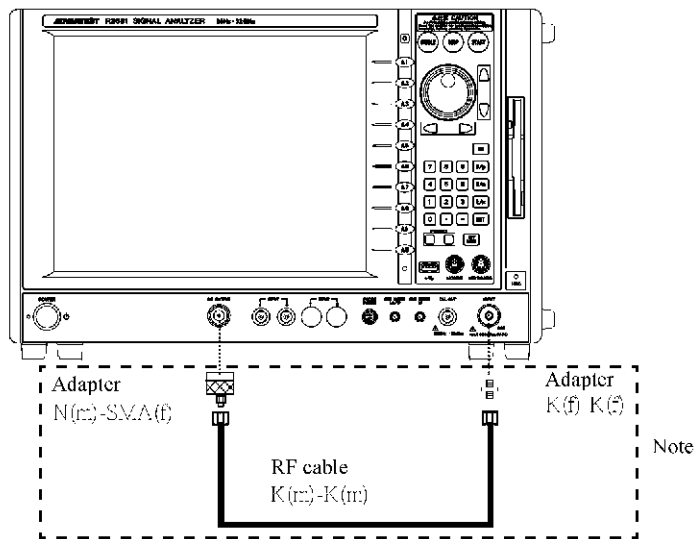

Note: The R3671 uses the N(m)-BNC(f) adapter and the BNC(m)-BNC(m) cable.

Figure 8-33 Non-harmonics Verification Connection Diagram

8.5.8 Non-harmonics

[Test procedure]

Initialization

1. Preset this instrument.  
Operation: **[Special]→[Preset]→[All]**

Connection

2. Connect the instrument as shown in Figure 8-33.

Option selection

3. Select the SG+AWG option.  
Operation: **[Config]→[SG+AWG Option]**

SG setting

4. Set the frequency to 50 MHz.  
Operation: {**FREQ**}, **Frequency**, **5**, **0**, **M/n**
5. Set the level to 0 dBm.  
Operation: {**AMPL**}, **Amplitude**, **0**, **ENT**
6. Set the RF output to ON.  
Operation: **[RF OUT ON]**

Measurement by using the SA function

7. Activate the SA.  
Operation: **[SA↔SG]**
8. Set the center frequency to 50 MHz.  
Operation: {**FREQ**}, **Center**, **5**, **0**, **M/n**
9. Set the frequency span to 50 kHz.  
Operation: {**SPAN**}, **Span**, **5**, **0**, **k/μ**
10. Set the marker on the waveform by using the marker search function.  
Operation: **{SERCH}**
11. Execute Peak→Ref.  
Operation: **{MKR→}**, **Peak→Ref**
12. Verify that the non-harmonics are within the specification.
13. Verify that the non-harmonics are within the specifications by switching the frequency span in the order of 500 kHz, 5 MHz, 50 MHz, and 100 MHz.

14. Activate the SG option.  
Operation: **|SA↔SG|**
15. Repeat steps 4 to 14 by changing the frequency according to the performance verification record sheet (8.6.8).

8.5.9 Modulation Accuracy

**8.5.9 Modulation Accuracy**

[Overview]

This section describes how to verify the modulation accuracy of the output signal by using the Modulation Analyzer function.

**CAUTION:** *The modulation analysis software option is needed to verify the modulation accuracy. This section describes by using the 3GPP modulation analysis software. For more information on how to operate the modulation analysis option for other modulation systems, refer to the operation manual related to each option.*

[Specifications]

EVM: <4 %rms (Carrier-Shift 2.5 MHz)

[Required instruments]

Product	Quantity		Recommended model
	R3681	R3671	
RF cable K(m)-K(m)	1	0	SF102
Adapter K(f)-K(f)	1	0	5A-SFF40(A)
Adapter N(m)-SMA(f)	1	0	HRM-554S
RF cable BNC(m)-BNC(m)	0	1	A01037-1500
Adapter N(m)-BNC(f)	0	2	JUG-201A/U

[Connection diagram]

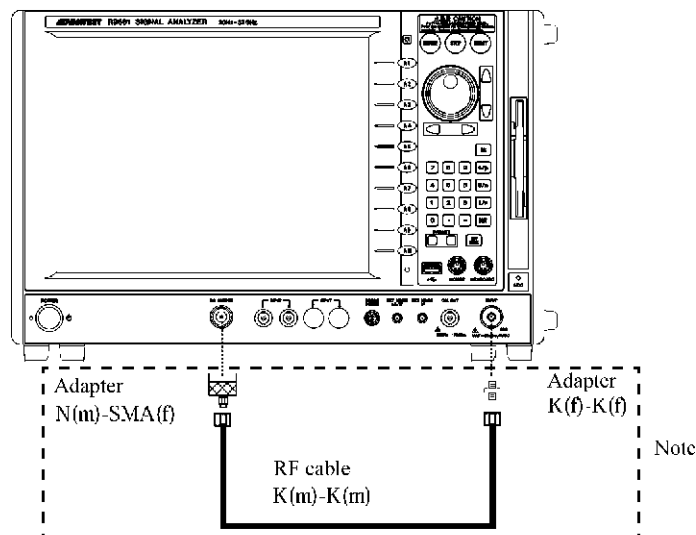

Note: The R3671 uses the N(m)-BNC(f) adapter and the BNC(m)-BNC(m) cable.

Figure 8-34 Modulation Accuracy Verification Connection Diagram

## [Test procedure]

## Initialization

1. Preset this instrument.  
Operation: **[Special]→[Preset]→[All]**

## Connection

2. Connect the instrument as shown in Figure 8-34.

## Option selection

3. Select the SG+AWG option.  
Operation: **[Config]→[SG+AWG Option]**

## AWG setting

4. Referring to 8.2, "Loading Waveform Data," load the waveform file "3GPP\_TM1\_64\_4."
5. Set the I/Q output mode to Fix Gain Path.  
Operation: **[I/Q Output]**, **[I/Q Output]**, **[Fix Gain Path(1V<sub>p-p</sub>)]**
6. After the setting is complete, close the **[I/Q Output Control]** dialog box.
7. Output the AWG signal.  
Operation: **[AWG ON]**

## SG setting

8. Set the frequency to 50 MHz.  
Operation: **{FREQ}**, **Frequency**, **5**, **0**, **M/n**
9. Set the level to 0 dBm.  
Operation: **{AMPL}**, **Amplitude**, **0**, **ENT**
10. Set the RF output to ON.  
Operation: **[RF OUT ON]**
11. Sets the modulation to ON.  
Operation: **[MOD ON]**

8.5.9 Modulation Accuracy

Measurement by using the Modulation Analyzer function

12. Cancel the SG+AWG option.  
Operation: **[Config]→[SG+AWG Option]**
13. Select the Modulation Analyzer function.  
Operation: **[Config]→[Modulation Analyzer]**
14. Select the Modulation.  
Operation: **[Modulation]→[3GPP DL]**
15. Set the center frequency to 50 MHz.  
Operation: {**FREQ**}, **Center**, **5**, **0**, **M/n**
16. Set to Auto Level.  
Operation: {**LEVEL**}, **Auto Level Set**
17. Set the number of carriers for the modulation analysis.  
Operation: {**MEAS SETUP**}, **Meas Parameters**, **[Multi Carrier Number]**, **4**, **ENT**
18. Set the offset frequency for the modulation analysis.  
Operation: **[1st Car]**, **[Carrier Frequency Offset]**, **-**, **7**, **.**, **5**, **M/n**  
**[2nd Car]**, **[Carrier Frequency Offset]**, **-**, **2**, **.**, **5**, **M/n**  
**[3rd Car]**, **[Carrier Frequency Offset]**, **2**, **.**, **5**, **M/n**  
**[4th Car]**, **[Carrier Frequency Offset]**, **7**, **.**, **5**, **M/n**
19. Close the **[Measurement Parameter Setup]** dialog box.  
Operation: **Return**
20. Start the modulation analysis.  
Operation: **START**
21. Verify that the EVM displayed value is within the specification.
22. Select the SG+AWG option.  
Operation: **[Config]→[SG+AWG Option]**
23. Repeat steps 8 to 22 by changing the frequency according to the performance verification record sheet (8.6.9).



## 8.5.10 Origin Offset

[Overview]

This section describes how to verify the origin offset of the output signal by using the SA function.

[Specifications]

Origin offset: <-15 dBc

[Required instruments]

Product	Quantity		Recommended model
	R3681	R3671	
RF cable K(m)-K(m)	1	0	SF102
Adapter K(f)-K(f)	1	0	5A-SFF40(A)
Adapter N(m)-SMA(f)	1	0	HRM-554S
RF cable BNC(m)-BNC(m)	0	1	A01037-1500
Adapter N(m)-BNC(f)	0	2	JUG-201A/U

[Connection diagram]

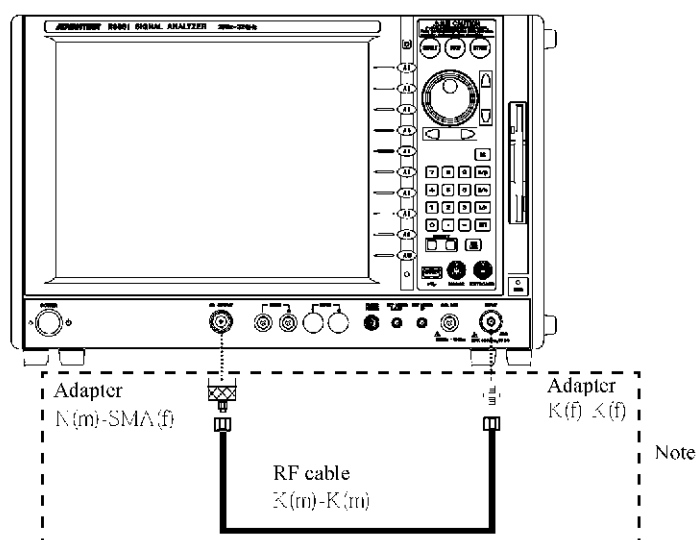

Note: The R3671 uses the N(m)-BNC(f) adapter and the BNC(m)-BNC(m) cable.

Figure 8-35 Origin Offset Verification Connection Diagram

### 8.5.10 Origin Offset

#### [Test procedure]

#### Initialization

1. Preset this instrument.  
Operation: **[Special]→[Preset]→[All]**

#### Connection

2. Connect the instrument as shown in Figure 8-35.

#### Option selection

3. Select the SG+AWG option.  
Operation: **[Config]→[SG+AWG Option]**

#### AWG setting

4. Referring to 8.2, "Loading Waveform Data," load the waveform file "3GPP\_TM1\_64\_1."
5. Set the I/Q output mode to Fix Gain Path.  
Operation: **[I/Q Output], [I/Q Output], [Fix Gain Path(1V<sub>p-p</sub>)]**
6. After the setting is complete, close the **[I/Q Output Control]** dialog box.
7. Output the AWG signal.  
Operation: **[AWG ON]**

#### SG setting

8. Set the frequency to 50 MHz.  
Operation: **{FREQ}, [Frequency], [5], [0], [M/n]**
9. Set the level to 0 dBm.  
Operation: **{AMPL}, [Amplitude], [0], [ENT]**
10. Set the RF output to ON.  
Operation: **[RF OUT ON]**
11. Sets the modulation to ON.  
Operation: **[MOD ON]**

## Measurement by using the SA function

12. Activate the SA.  
Operation: [SA↔SG]
13. Set the center frequency to 50 MHz.  
Operation: {FREQ}, **Center**, **5**, **0**, **M/n**
14. Set the frequency span to 20 MHz.  
Operation: {SPAN}, **Span**, **2**, **0**, **M/n**
15. Measure the channel power.  
Operation: {MENU2}, {POWER}, **Channel Power**
16. After the measurement is complete, set the channel power to OFF.  
Operation: **Channel Power Off**
17. Set the frequency span to 5 kHz.  
Operation: {SPAN}, **Span**, **5**, **k/μ**
18. Measure the carrier leakage level at the center frequency by using the marker function.  
Operation: {MENU1}, {MKR}, **Marker**, **5**, **0**, **M/n**
19. Verify that the difference between the channel power measured in step 15 and the carrier leakage level measured in step 18 is within the specification.
20. Activate the SG option.  
Operation: [SA↔SG]
21. Repeat steps 8 to 20 by changing the frequency according to the performance verification record sheet (8.6.10).

8.5.11 ACLR

8.5.11 ACLR

[Overview]

This section describes how to verify the harmonics of the output signal by using the SA function.

[Specifications]

<-53 dBc

[Required instruments]

Product	Quantity		Recommended model
	R3681	R3671	
RF cable K(m)-K(m)	1	0	SF102
Adapter K(f)-K(f)	1	0	5A-SFF40(A)
Adapter N(m)-SMA(f)	1	0	HRM-554S
RF cable BNC(m)-BNC(m)	0	1	A01037-1500
Adapter N(m)-BNC(f)	0	2	JUG-201A/U

[Connection diagram]

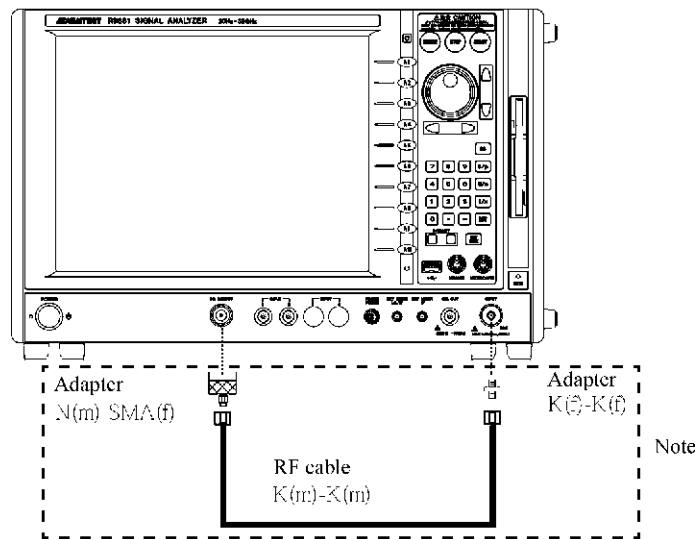

Note: The R3671 uses the N(m)-BNC(f) adapter and the BNC(m)-BNC(m) cable.

Figure 8-36 ACLR Verification Connection Diagram

## [Test procedure]

## Initialization

1. Preset this instrument.  
Operation: **[Special]→[Preset]→[All]**

## Connection

2. Connect the instrument as shown in Figure 8-36.

## Option selection

3. Select the SG+AWG option.  
Operation: **[Config]→[SG+AWG Option]**

## AWG setting

4. Referring to 8.2, "Loading Waveform Data," load the waveform file "3GPP\_TM1\_64\_1."
5. Set the I/Q output mode to Fix Gain Path.  
Operation: **[I/Q Output]**, **[I/Q Output]**, **[Fix Gain Path(1V<sub>p-p</sub>)]**
6. After the setting is complete, close the **[I/Q Output Control]** dialog box.
7. Output the AWG signal.  
Operation: **[AWG ON]**

## SG setting

8. Set the frequency to 50 MHz.  
Operation: **{FREQ}**, **Frequency**, **5**, **0**, **M/n**
9. Set the level to 0 dBm.  
Operation: **{AMPL}**, **Amplitude**, **0**, **ENT**
10. Set the RF output to ON.  
Operation: **[RF OUT ON]**
11. Sets the modulation to ON.  
Operation: **[MOD ON]**

### 8.5.11 ACLR

#### Measurement by using the SA function

12. Activate the SA.  
Operation: [SA↔SG]
13. Set the center frequency to 50 MHz.  
Operation: {FREQ}, **Center**, **5**, **0**, **M/n**
14. Set the frequency span to 50 MHz.  
Operation: {SPAN}, **Span**, **5**, **0**, **M/n**
15. Verify that the ACLR is within the specification by using the ACP or ACLR measurement function.  
Operation: {MENU2}, {POWER}, **ACP**
16. Activate the SG option.  
Operation: [SA↔SG]
17. Repeat steps 8 to 16 by changing the frequency according to the performance verification record sheet (8.6.11).

## 8.5.12 External IQ Input

### [Overview]

This section describes how to verify the modulation accuracy of the RF output signal, which is modulated by the base-band signal input from the external IQ signal connectors, by using the Modulation Analyzer function as described in section 8.5.9.

---

**CAUTION:** *The modulation analysis software option is needed to verify the modulation accuracy. This section describes by using the 3GPP modulation analysis software. For more information on how to operate the modulation analysis option for other modulation systems, refer to the operation manual related to each option.*

---

### [Specifications]

EVM: <4 %rms

### [Required instruments]

Product	Quantity		Recommended model
	R3681	R3671	
RF cable K(m)-K(m)	1	0	SF102
RF cable BNC(m)-BNC(m)	2	3	A01037-1500
Adapter K(f)-K(f)	1	0	5A-SFF40(A)
Adapter N(m)-SMA(f)	1	0	HRM-554S
Adapter SMA(m)-BNC(f)	4	4	HRM-517(09)
Adapter N(m)-BNC(f)	0	2	JUG-201A/U

8.5.12 External IQ Input

[Connection diagram]

<Front>

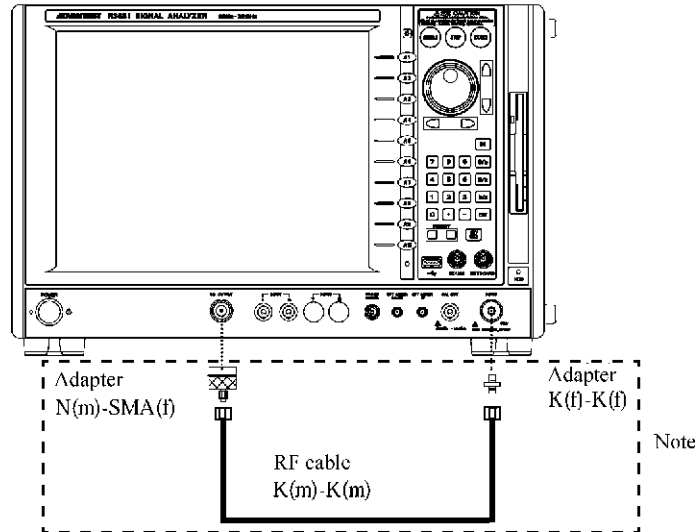

Note: The R3671 uses the N(m)-BNC(f) adapter and the BNC(m)-BNC(m) cable.

<Rear>

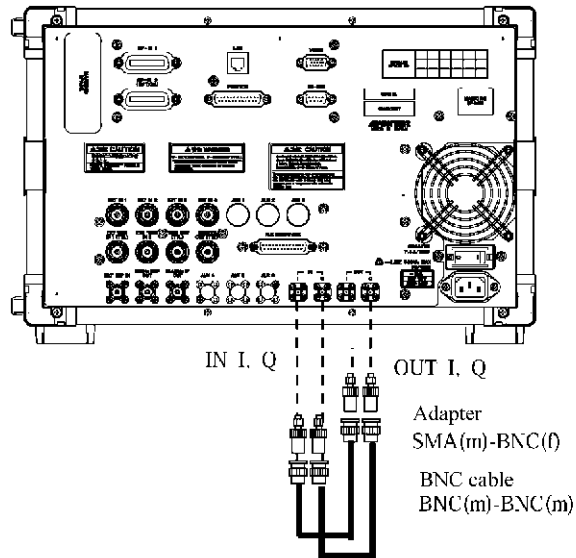

Figure 8-37 External IQ Input Verification Connection Diagram

[Test procedure]

Initialization

1. Preset this instrument.  
Operation: |Special|→|Preset|→|All|



## Connection

2. Connect the instrument as shown in Figure 8-37.

## Option selection

3. Select the SG+AWG option.  
Operation: [Config]→[SG+AWG Option]

## AWG setting

4. Referring to 8.2, "Loading Waveform Data," load the waveform file "3GPP\_TM1\_64\_4."
5. Set the I/Q output mode to Fix Gain Path.  
Operation: [I/Q Output], [I/Q Output], [Fix Gain Path(1V<sub>p-p</sub>)]
6. After the setting is complete, close the [I/Q Output Control] dialog box.
7. Output the AWG signal.  
Operation: [AWG ON]

## SG setting

8. Set the frequency to 50 MHz.  
Operation: {FREQ}, [Frequency], [5], [0], [M/n]
9. Set the level to 0 dBm.  
Operation: {AMPL}, [Amplitude], [0], [ENT]
10. Set the RF output to ON.  
Operation: [RF OUT ON]
11. Sets the modulation to ON.  
Operation: [MOD ON]
12. Select the external IQ input.  
Operation: {MOD}, [I/Q Input Source] (External)
13. Set the external IQ input attenuator to 0 dB.  
Operation: {MOD}, [I/Q ATT], [0 dB]

8.5.12 External IQ Input

Measurement by using the Modulation Analyzer function

14. Cancel the SG+AWG option.  
Operation: **[Config]→[SG+AWG Option]**
15. Select the Modulation Analyzer function.  
Operation: **[Config]→[Modulation Analyzer]**
16. Select the Modulation.  
Operation: **[Modulation]→[3GPP DL]**
17. Set the center frequency to 50 MHz.  
Operation: **{FREQ}, [Center], [5], [0], [M/n]**
18. Set to Auto Level.  
Operation: **{LEVEL}, [Auto Level Set]**
19. Set the number of carriers for the modulation analysis.  
Operation: **{MEAS SETUP}, [Meas Parameters], [Multi Carrier Number], [4], [ENT]**
20. Set the offset frequency for the modulation analysis.  
Operation: **[1st Car], [Carrier Frequency Offset], [-], [7], [.] , [5], [M/n]  
[2nd Car], [Carrier Frequency Offset], [-], [2], [.] , [5], [M/n]  
[3rd Car], [Carrier Frequency Offset], [2], [.] , [5], [M/n]  
[4th Car], [Carrier Frequency Offset], [7], [.] , [5], [M/n]**
21. Close the **[Measurement Parameter Setup]** dialog box.  
Operation: **[Return]**
22. Start the modulation analysis.  
Operation: **[START]**
23. Verify that the EVM displayed value is within the specification.

## 8.6 SG Performance Verification Record Sheets

*NOTE: The frequency range is  $\leq 3$  GHz in the R3671.*

### 8.6.1 Frequency Accuracy

Frequency setting	Specification (Min.) [MHz]	Measured value [MHz]	Specification (Max.) [MHz]	Pass/Fail
50 MHz to 6 GHz (50 MHz Step)	checked			

### 8.6.2 Level Accuracy

Modulation OFF

Level setting	Specification (Min.) [dBm]	Measured value [dBm]	Specification (Max.) [dBm]	Pass/Fail
Frequency setting 50 MHz to 6 GHz (50 MHz Step)	+13 dBm	+11.6	+14.4	
	+10 dBm	+8.6	+11.4	
	+5 dBm	+3.6	+6.4	
	0 dBm	-1.4	+1.4	
	-5 dBm	-6.4	-3.6	
	-10 dBm	-11.4	-8.6	
	-15 dBm	-16.4	-13.6	

Modulation ON

Level setting	Specification (Min.) [dBm]	Measured value [dBm]	Specification (Max.) [dBm]	Pass/Fail
Frequency setting 50 MHz to 6 GHz (50 MHz Step)	+10 dBm	+8.6	+11.4	
	+5 dBm	+3.6	+6.4	
	0 dBm	-1.4	+1.4	
	-5 dBm	-6.4	-3.6	
	-10 dBm	-11.4	-8.6	
	-15 dBm	-16.4	-13.6	

8.6.3 Attenuator Hold Level Variable Range

**8.6.3 Attenuator Hold Level Variable Range**

Frequency setting [MHz]	Specification (Min.) [dB]	Measured value [dB]	Specification (Max.) [dB]	Pass/Fail
50	10		-	
500	10		-	
1000	10		-	
1500	10		-	
2000	10		-	
2500	10		-	
3000	10		-	
3500	10		-	
4000	10		-	
4500	10		-	
5000	10		-	
5500	10		-	
6000	10		-	

**8.6.4 ALC Hold ADJ Accuracy**

Frequency setting [MHz]	Specification (Min.) [dB]	Measured value [dB]	Specification (Max.) [dB]	Pass/Fail
50	-		0.25	
3000	-		0.25	
6000	-		0.25	

**8.6.5 SSB Phase Noise**

Frequency setting [MHz]	Specification (Min.) [dBc/Hz]	Measured value [dBc/Hz]	Specification (Max.) [dBc/Hz]	Pass/Fail
500	-		-115	
6000			-115	

**8.6.6 Broadband Noise**

Frequency setting [MHz]	Specification (Min.) [dBc/Hz]	Measured value [dBc/Hz]	Specification (Max.) [dBc/Hz]	Pass/Fail
2000	-		-132	

**8.6.7 Harmonics**

Frequency setting [MHz]	Specification (Min.) [dBc]	Measured value [dBc]	Specification (Max.) [dBc]	Pass/Fail
50	-		-30	
500	-		-30	
1000	-		-30	
1500	-		-30	
2000	-		-30	
2500	-		-30	
3000	-		-30	
3500	-		-30	
4000	-		-30	
4500	-		-30	
5000	-		-30	
5500	-		-30	
6000	-		-30	

8.6.8 Non-harmonics

**8.6.8 Non-harmonics**

Frequency setting [MHz]	Specification (Min.) [dBc]	Measured value [dBc]	Specification (Max.) [dBc]	Pass/Fail
50	-		-65	
500	-		-65	
1000	-		-65	
1500	-		-65	
2000	-		-65	
3000	-		-65	
4000	-		-65	
5000	-		-65	
6000	-		-65	

**8.6.9 Modulation Accuracy**

Frequency setting [MHz]	Specification (Min.) [%rms]	Measured value [%rms]	Specification (Max.) [%rms]	Pass/Fail
50	-		-4	
500	-		-4	
1000	-		-4	
1500	-		-4	
2000	-		-4	
3000	-		-4	
4000	-		-4	
5000	-		-4	
6000	-		-4	

**8.6.10 Origin Offset**

Frequency setting [MHz]	Specification (Min.) [dBc]	Measured value [dBc]	Specification (Max.) [dBc]	Pass/Fail
50	-		-15	
500	-		-15	
1000	-		-15	
1500	-		-15	
2000	-		-15	
3000	-		-15	
4000	-		-15	
5000	-		-15	
6000	-		-15	

**8.6.11 ACLR**

Frequency setting [MHz]	Specification (Min.) [dBc]	Measured value [dBc]	Specification (Max.) * [dBc]	Pass/Fail
50	-		-53	
500	-		-53	
1000	-		-53	
1500	-		-53	
2000	-		-53	
3000	-		-53	
4000	-		-53	
5000	-		-53	
6000	-		-53	

\*: -60: Option73 ACLR mode

**8.6.12 External IQ Input**

Frequency setting [MHz]	Specification (Min.) [%rms]	Measured value [%rms]	Specification (Max.) [%rms]	Pass/Fail
50	-		-4	





## APPENDIX

This section describes the following items:

- A.1 Method to Create a Waveform File
- A.2 Principle of Operation
- A.3 Error Codes
- A.4 Description of Standard Waveform Generation Software

### A.1 Method to Create a Waveform File

This section describes how to generate waveform files.

#### A.1.1 Waveform File Configuration

A waveform file is composed of the header, which includes a file generation date and information on settings for the AWG, and the waveform data part.

Text data is used for descriptions in the header, and binary data is used for descriptions in the waveform data part.

Header
Comments, a file generation date and settings for the AWG are described.
Waveform data part
IQ data is stored. 32-bit frames are used to store I and Q data in alternating sequence (IQIQ...).

---

**MEMO:** *Unless setting information is written in the header, the settings are not reflected in the AWG.*

---

---

**IMPORTANT:** *A header is not always required for waveform files. A waveform file can be configured only with waveform data, without a header.*

---

A.1.2 Header

**A.1.2 Header**

The following fields are included in a header:

Header	Description
COMMENT	Comment input field
DATE	Date and time field
IQFILTER	I/Q filter information
IQGAIN	I/Q gain information
IQOFFSET	I/Q offset information
MARKERMODE	Marker mode information
MARKER1	Marker 1 information
MARKER2	Marker 2 information
STARTTRIGGER	Start trigger information
OUTPUTSEQUENCE	Output sequence information
SAMPLINGFREQ	Sampling frequency setting information
IQOUTPUT	Output path information
ALC MODE	ALC mode information

### A.1.3 Header Syntax

The syntax for each header field and description examples in use of the syntax are given.

- COMMENT

Enter comments in the COMMENT field.

Syntax	Description example
{ <b>COMMENT:</b> <i>Comment</i> }	{COMMENT:Sample wave1 for QPSK}
	In this example "Sample wave1 for QPSK" is the input.

- DATE

Enter the date in this field.

Syntax	Description example
{ <b>DATE:</b> <i>yyyy/mm/dd;hh:mm:ss</i> }	{DATE:2003/01/01;12:00:00}
	In this example, 12:00:00 noon on January 1, 2003 is the input.

- IQFILTER

Enter settings for the I/Q base-band filter in this field.

Syntax	Description example
{ <b>IQFILTER:</b> <i>Filter</i> }	{IQFILTER:FLT2_5M}
Filter:FLT2_5M/FLT50M/THR	In this example, 2.5 MHz is set for the I/Q base-band filter.

- IQGAIN

Enter I/Q signal output levels in this field.

Syntax	Description example
{ <b>IQGAIN:</b> <i>I level;Q level</i> }	{IQGAIN:500E-3;500E-3}
	In this example, 0.5 V <sub>p-p</sub> is set for each output level of the I and Q signals.

A.1.3 Header Syntax

- IQOFFSET

Enter the DC offset voltages that are to be added to the I/Q signals.

Syntax	Description example
{ <b>IQOFFSET</b> : <i>I offset</i> ; <i>Q offset</i> }	{ <b>IQOFFSET</b> :100E-3;-100E-3}
	In this example, the addition of a DC offset voltage of 0.1 V is set for the I signal, and the addition of an offset voltage of -0.1 V is set for the Q signal.

- MARKERMODE

Enter a marker mode in this field.

Syntax	Description example
{ <b>MARKERMODE</b> : <i>Mode</i> }	{ <b>MARKERMODE</b> :WFM}
Mode:      WFM/SEQ	In this example, the memory marker is selected for the marker generation method.

- MARKER1

Enter settings for marker 1 in this field.

Syntax
{ <b>MARKER1</b> : <i>On/Off</i> ; <i>Polarity</i> ; <i>Start offset period</i> ; <i>High period</i> ; <i>Low period</i> ; <i>Loop number</i> }
On/Off:    ON/OFF
Polarity:   POS/NEG

Description example
{ <b>MARKER1</b> :ON;POS;0;100;100;1}
In this example, marker 1 is set to On, the polarity of marker 1 is set to Pos, the number of offset start periods is set to 0 samples, the high period is set to 100 samples, the low period is set to 100 samples, and the number of repetitions is set to 1. (Enter dummy data except for On/Off if the memory marker function is selected.)

- MARKER2

Enter settings for marker 2 in this field.

Syntax
{ <b>MARKER2</b> : <i>On/Off;Polarity;Start offset period;High period;Low period;Loop number</i> }
On/Off: ON/OFF Polarity: POS/NEG

Description example
{ <b>MARKER2</b> :OFF;NEG;0;100;100;1}
In this example, marker 2 is set to Off, the polarity of marker 2 is set to Neg, the number of offset start periods is set to 0 samples, the high period is set to 100 samples, the low period is set to 100 samples and the number of repetitions is set to 1. (Enter dummy data except for On/Off if the memory marker function is selected.)

- STARTTRIGGER

Enter settings for the start trigger in this field.

Syntax	Description example
{ <b>STARTTRIGGER</b> : <i>Mode;Polarity</i> }	{ <b>STARTTRIGGER</b> :LINK;POS} { <b>STARTTRIGGER</b> :INT;POS}
Mode: INT/LINK Polarity: POS/NEG	(In the INTERNAL mode, enter dummy data in Polarity.)

A.1.3 Header Syntax

- **OUTPUTSEQUENCE**

Enter settings for output sequence in this field.

Syntax	Description example
<b>{OUTPUTSEQUENCE:Mode;Parameter}</b>	<b>{OUTPUTSEQUENCE:CONT}</b>
Mode: CONT /SINGL/GATE	In this example, the CONTINUOUS mode is set for the waveform generation sequence of the AWG.
Parameter: Loop Number (in the SINGLE mode)	<b>{OUTPUTSEQUENCE:SINGL;3}</b>
EDGE/LEV (in the GATE mode)	In this example, settings for the waveform generation sequences for the AWG are made so that the sequence is repeated three times in the SINGLE mode.
	<b>{OUTPUTSEQUENCE:GATE;EDGE}</b>
	In this example, waveform generation sequence for the AWG is set to the GATE mode and control of waveform data output is set to the EDGE.

- **SAMPLINGFREQ**

Enter settings for the sampling frequency in this field.

Syntax	Description example
<b>{SAMPLINGFREQ:Freq}</b>	<b>{SAMPLINGFREQ:200E+6}</b>
	In this example, the sampling frequency is set to 200 MHz.

- **IQOUTPUT**

Enter I/Q output path in this field.

Syntax	Description example
<b>{IQOUTPUT:Path}</b>	<b>{IQOUTPUT:FIX}</b>
Path: FIX/VAR	In this example, the I/Q output path is set to the Fix Gain Path (1 V <sub>p-p</sub> ).

- **ALC Mode**

Enter a ALC mode in this field.

Syntax	Description example
<b>{ALCMOD:mode}</b>	<b>{ALCMOD:HOLD}</b>
mode: NORM/HOLD	In this example, the Hold is selected as the ALC mode.

### A.1.4 Waveform Data Generation (Waveform Data Part)

This section describes how to generate waveform data.

- Waveform data generation procedures  
Generate waveform data following the flow indicated in Figure A-1.

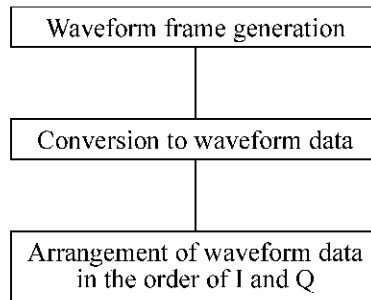

Figure A-1 Waveform Data Generation Procedures

- Waveform frame  
Data for one sample is written in a 32-bit frame as shown in Figure A-2 and Figure A-3.

#### I waveform frame

Waveform data is written in bit 13 through bit 0 in the 14-bit offset binary format.  
 Bit 14 is used as the field where data for memory marker 1 is to be written.  
 Bit 15 is used as the field where data for memory marker 2 is to be written.  
 Zero (0) is written in each of bit 31 through bit 16.

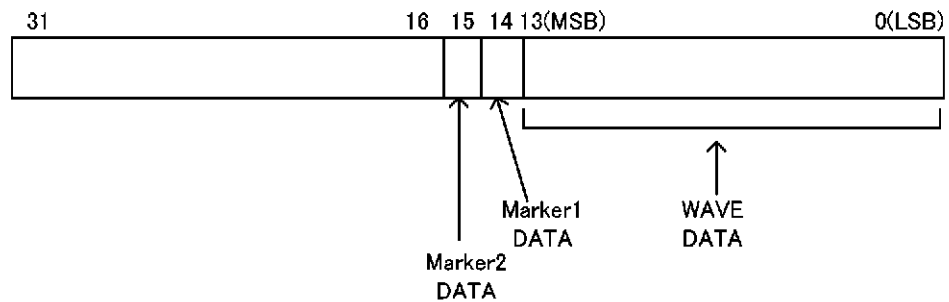

Figure A-2 I Waveform Frame

A.1.4 Waveform Data Generation (Waveform Data Part)

Q waveform frame

Waveform data is written in bit 13 through bit 0 in the 14-bit offset binary format.

Zero (0) is written in each of bit 31 through bit 14.

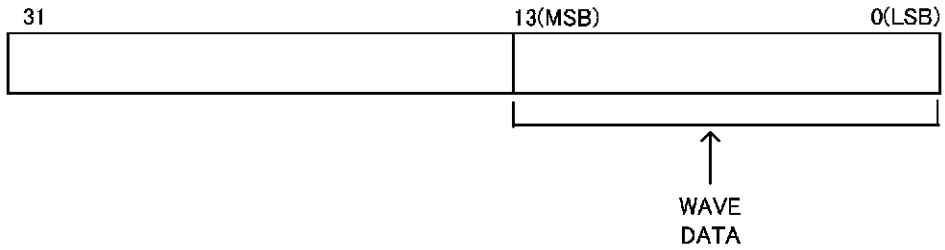

Figure A-3 Q Waveform Frame

- Conversion of waveform frames to waveform data (concerning endian)

A waveform frame is converted to waveform data as shown in Figure A-4.

The upper word of the waveform frame is replaced with the lower word and the lower word is replaced with the upper word. In each of the words in their new positions, the upper byte is replaced with the lower byte and the lower byte is replaced with the upper byte. The resultant data is written in a file as the waveform data.

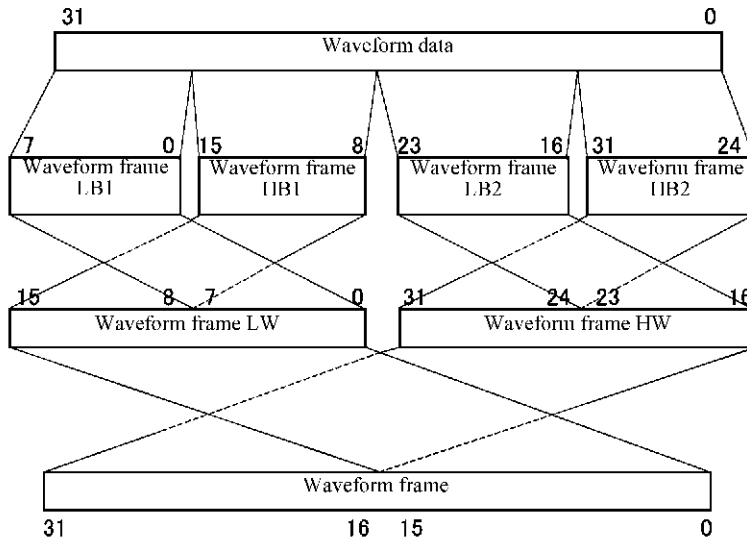

Figure A-4 Conversion



- Waveform data

Enter waveform data as shown in the following:

**{WAVEDATA:total number of bytes; I Q I Q I Q I Q ..... I Q }**

Enter WAVEDATA, the header name, following the left brace ({}), enter a colon, and then enter the total number of waveform data bytes, a decimal number. After that, enter a semicolon, and enter I and Q waveform data in alternating order (starting with I data) repeatedly. Enter a right brace (}) to end input.

Input example

**{WAVEDATA:8192; I Q I Q I Q I Q ..... I Q }**

---

**IMPORTANT:** *The number of waveform data samples must be 1024 or more for each of I and Q data types. Waveform data with less than 1024 samples cannot be output in this AWG. Also, the number of samples of each of I and Q data must be a multiple of four. If the number is not a multiple of four, normal waveforms cannot be obtained in this AWG.*

---

- Relationships between 14-bit offset binary data and output

If the output mode is set for Fix Gain Path(1V<sub>P-P</sub>),

$$+0.5V=0x3FFF$$

$$0V=0x2000$$

$$-0.5V=0x1$$

then there are the relationships indicated in Figure A-5 between them.

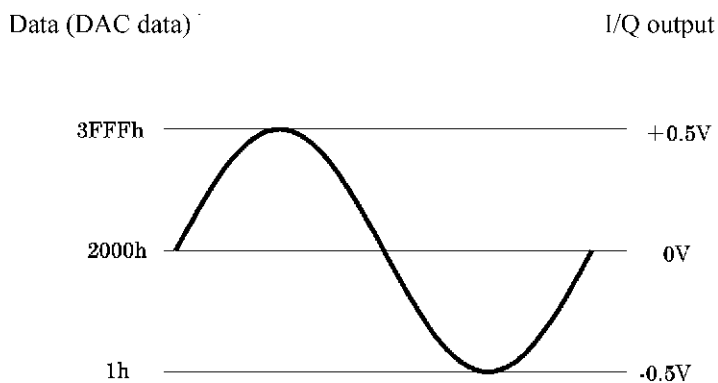

Figure A-5 Relationships between DAC Data and I/Q Output Voltages (for Fix Gain Path)

A.1.4 Waveform Data Generation (Waveform Data Part)

If Variable Gain Path is set for the output mode, the relationships become as shown in Figure A-6.

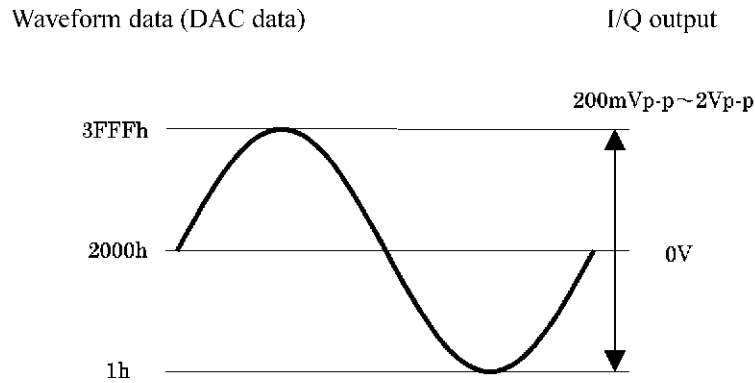

Figure A-6 Relationships between DAC Data and I/Q Output Voltages (for Variable Gain Path)

- Program samples

The following describes a C language program to output a 5 MHz sine wave with a sampling frequency of 200 MHz.

Example 1 The following is the program that generates the source signal for the waveform data:

```
#include <stdio.h>
#include <math.h>
main()
{
    #define SAMPLES 2000
    FILE *fp;
    int n;
    float i,q;

    fp=fopen("SINCOS.TXT","w");

    for(n=0;n<SAMPLES;n++){
        i=sin(2.0*3.1415926535*50.0/2000.0*(float)n);
        q=cos(2.0*3.1415926535*50.0/2000.0*(float)n);
        fprintf(fp,"%f %f\n",i,q);
    }
    fclose(fp);
}
```

Example 2 The following is a C language program that normalizes the signal to generate the waveform frames, converts the frames to the waveform data and creates the waveform file to store the waveform data generated.

```
main()
{
    #define SAMPLES 2000
    #define BYTE 4 // 32 bits = 4 bytes
    #define TOTAL_BYTES SAMPLES*BYTE*2
    FILE *fp_s,*fp_d;
    float i_float,q_float;
    unsigned int i_int,q_int;

    fp_s=fopen("SINCOS.TXT","r");
    fp_d=fopen("SINCOS.AWV","wb");

    // The header is written.
    fprintf(fp_d, "{COMMENT:Test Signal fout=5MHz Sampling Freq.=200MHz}\n");
    fprintf(fp_d, "{DATE:2003/01/01;12:00:00}\n");

    // Waveform data is written.
    fprintf(fp_d, "{WAVEDATA:%d; ", TOTAL_BYTES);

    while(1){
        if(fscanf(fp_s,"%f %f",&i_float,&q_float)==EOF) break;

        // The normalization operation is performed and the waveform frames are generated.
        i_int=(unsigned int)((float)0x2000+i_float*(float)0x1fff);
        q_int=(unsigned int)((float)0x2000+q_float*(float)0x1fff);

        // The waveform frames are converted to waveform data, which is written in the file.
        fwrite(&i_int,1,4,fp_d);
        fwrite(&q_int,1,4,fp_d);
    }
    fprintf(fp_d, " }");

    fclose(fp_s);
    fclose(fp_d);
}
```

A.2 Principle of Operation

**A.2 Principle of Operation**

This section describes the principle of operation of this option.

This option consists of the AWG block, Modulator block, RF block, and Local block.

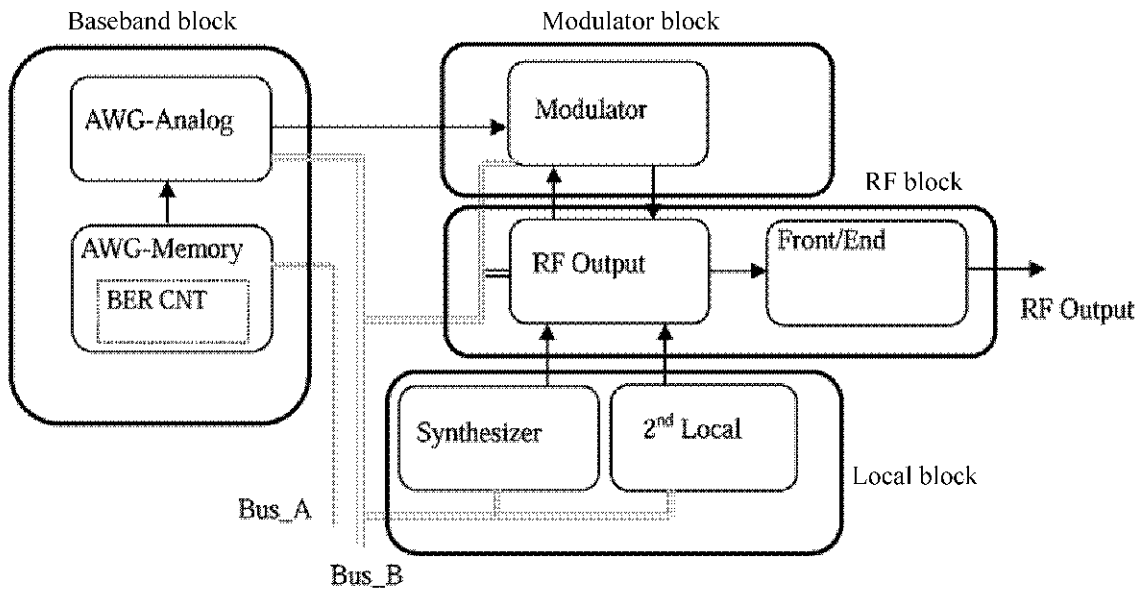

Figure A-7 Block Diagram

- AWG block

The AWG (option) is composed of two blocks: the memory block and the analog block.

- Memory block

The memory block is composed of the following portions: a clock generator to determine sampling frequencies, a microprocessor to provide communications with the main unit CPU, the memory to store waveform data, a data controller to control waveform data output, marker output and trigger input, and a D/A converter to convert digital I/Q data output from the memory to the corresponding analog I/Q data.

- Analog block

The analog block is composed of the following portions: a base-band filter whose input is the I/Q signal from the memory block, a sum amplifier to set I/Q signal levels, and an output amplifier to add a DC offset voltage to the I/Q signal and output the resultant signal.

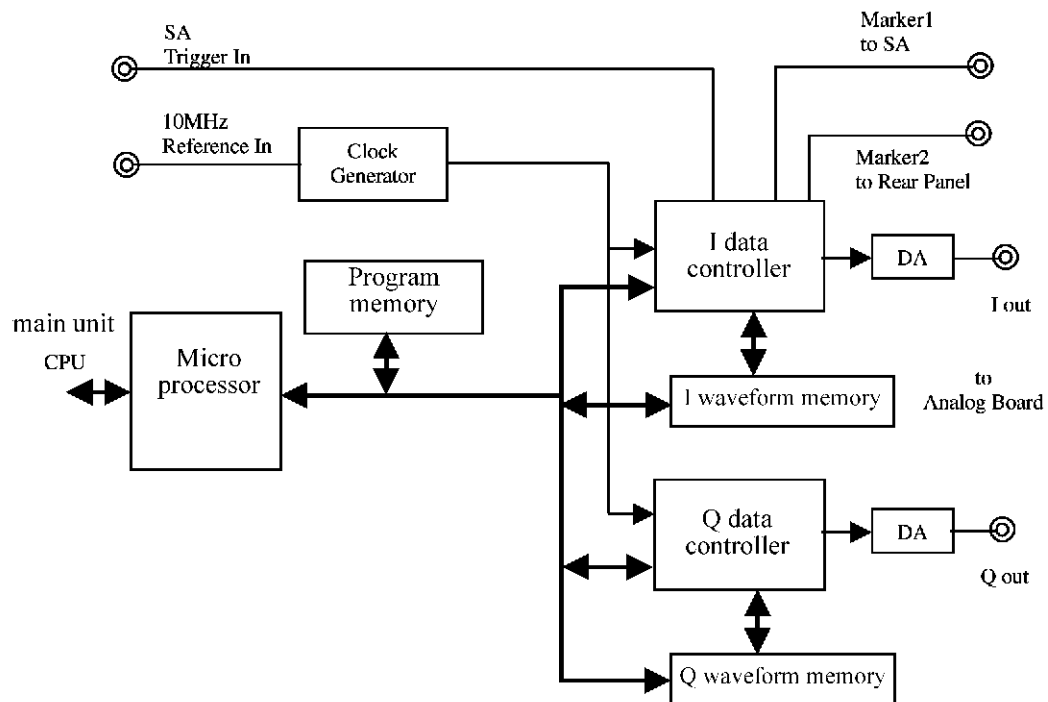

Figure A-8 Memory Block Diagram

A.2 Principle of Operation

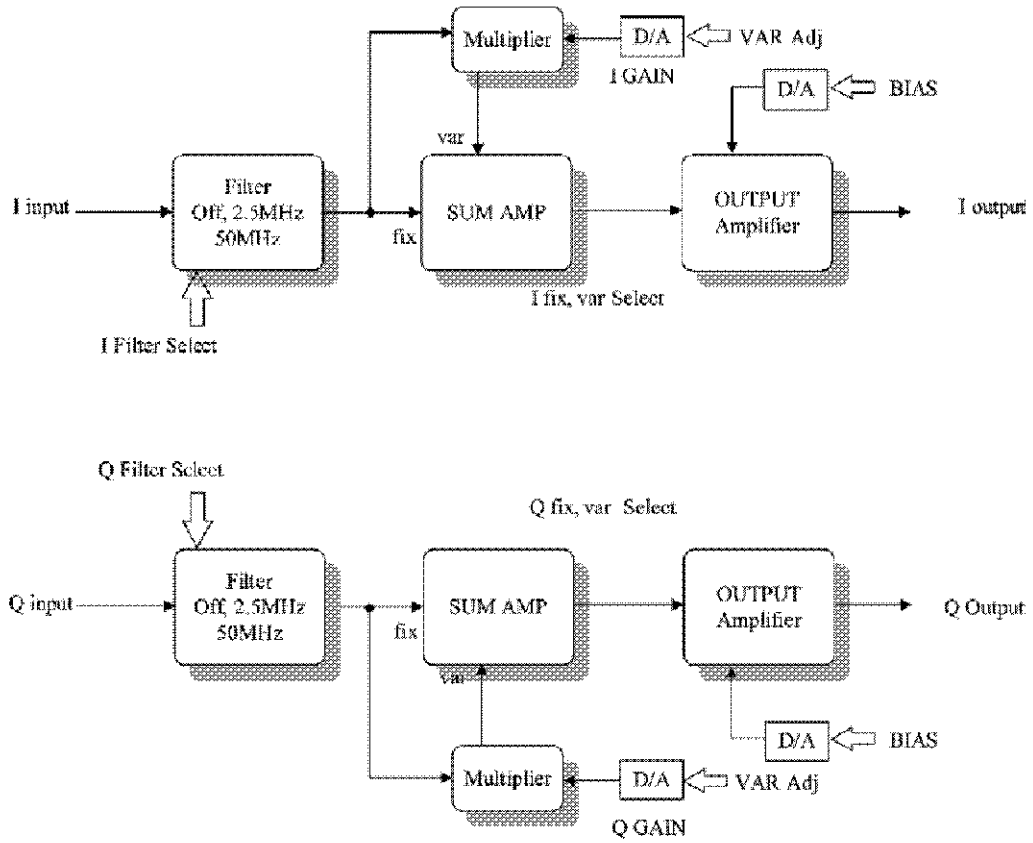

Figure A-9 Analog Board Block Diagram

- Modulator block
  - This block generates the modulation signal by using both the I/Q signals, which are from the AWG-Analog block (or rear panel), and the Local signal, which is from the RF block. This block has a calibration function itself and automatically adjusts the errors of the phase, amplitude, offset voltage between the I and Q signals to achieve the optimized modulation conditions. If the internal I and Q signals are used, this block optimizes the variable attenuator, which is set to the input stage of the modulator, according to Peak Factor written in the header of the waveform file. The value of the phase, amplitude, offset voltage, and the attenuator can be optimized by the manual operations.  
The frequency characteristic in the modulation frequency range is corrected by using the data, which is stored in the internal ROM in advance.
- RF block
  - This block has a function that amplifies the signals from the Local block and Modulation block, controls the level, and finally outputs the RF signal. This block includes the RF Output module, P-ATT(Programmable Attenuator), and RF Front/End which consists of the high frequency switches. The following describes the operations of the RF Output module.

#### <Filter Bank>

The front stage of Filter Bank consists of a circuit that divides the YTO output signal from the Synthesizer block and the filters for each path. This output signal is supplied to Modulator as the Local signal when the modulation is set to ON, and directly connected to the filters in the back stage when the modulation is set to OFF. The filters for each frequency band are inserted in the path through the output signal from the divider circuit or Modulator in the back stage of Filter Bank.

#### <Output AMP>

Output AMP consists of the amplifier, in which the Filter Bank output signal is amplified to the output level, and the variable attenuator, which is used to control ALC, and the ALC detector. However, the path is switched to the Lo Band Converter side when the low band frequency is output.

#### <Low band Converter>

Low band Converter is the path for the low band frequency and consists of the mixer, in which the 2<sup>nd</sup> Local signal is heterodyned with the output signal from the Filter Bank or Modulator, and the amplifier, in which the signal is amplified to the output level, and the variable attenuator, which is used to control ALC, and the detector.

#### <Mod ALC>

Mod ALC is a circuit in which the ALC detector output voltage from Power Amp and Low Band Converter are compared with the reference voltage, the feedback is performed to each variable attenuator, and the RF Output level is stabilized. This circuit includes the RMS detector circuit for the broadband modulation signal.

- Local block
  - In Synthesizer, the YTO high purity signal is supplied for the local signal when the modulation signal is output, and is supplied for the RF signal when the non-modulation signal is output. Also the local signal is supplied to the AGC circuit for the broadband modulation. In 2<sup>nd</sup> Local, the local signal for Low band Converter in the RF block is generated. These signals are locked by the 10 MHz reference frequency in the system.

## A.3 Error Codes

**A.3 Error Codes**

This section describes error messages indicated for this option.

Descriptions are made for the following items:

- Error number
- Displayed message
- Description

Error number	Displayed message	Description
-1550	Invalid AWG Frequency-Correction Data. Please contact a service engineer.	Internal frequency correction data is improper. Please request repair by ADVANTEST or its agencies.
-1551	Invalid SG Frequency-Correction Data1. Please contact a service engineer.	The internal frequency correction data is incorrect. Request ADVANTEST or one of its representatives to repair this instrument.
-1552	Invalid SG Frequency-Correction Data2. Please contact a service engineer.	The internal frequency correction data is incorrect. Request ADVANTEST or one of its representatives to repair this instrument.
-1553	Invalid SG Frequency-Correction Data3. Please contact a service engineer.	The internal frequency correction data is incorrect. Request ADVANTEST or one of its representatives to repair this instrument.
-4200	Invalid waveform file Header.	The header information on the waveform file is improper.
-4201	Invalid waveform file Data Size.	The data length information on the waveform file is improper.
-4202	Empty waveform Memory.	Waveform data is not loaded on the memory. Load waveform data, and then execute.
-4203	Marker sequencer points exceeds total waveform length.	The set Marker Sequencer length is longer than that of the waveform data.
-4210	Overflow BER Measurement Bit Length.	The total bit length of the BER measurement has overflowed.
-4211	Repeat Measurement not available in this Start Trigger/Sync mode.	With the current setting of Start Trigger/Sync Mode, measurement cannot be conducted repeatedly.
-4220	Amplitude is out of range in ATT Hold On mode.	Level setting in the attenuator hold mode is outside the range.
-4221	Unlevel.	Output level accuracy is not guaranteed. ALC circuit operates incorrectly.
-4230	Modulation Adjust Error.	The automatic adjustment of the modulator is incorrect.
-4240	Not available RF OUT is OFF.	Cannot be executed because the RF signal output is set to OFF.



Error number	Displayed message	Description
-4241	Not available MOD is off.	Cannot be executed because the modulation function is set to OFF.
-4242	Not available AWG OUT is off.	Cannot be executed because the AWG waveform output is set to OFF.
-4243	Not available AWG Output Sequence is Single.	Cannot be executed because the AWG output sequence is set to Single.
-4244	Not available Input Level is too low.	Cannot be executed because the input signal level is too low.
-4300	Unlock AWG Sampling Clock PLL.	The PLL circuit for the Sampling Clock used in the AWG system is unlocked. Please request repair by ADVANTEST or its agencies.
-4500	AWG Cal data is not enough. Please execute AWG Cal	No AWG CAL data is provided. Please execute AWG CAL.
-4501	AWG Cal file read/write error.	An error has been generated in input/output of the AWG CAL file.
-4510	AWG ICH (Differential I) DC offset out of range	The correction of the ICH DC offset has failed.
-4511	AWG ICH (Differential *I) DC offset out of range	The correction of the ICH DC offset has failed.
-4512	AWG ICH (Single end I) DC offset out of range	The correction of the ICH DC offset has failed.
-4513	AWG ICH (Fixed Amp I ) DC offset out of range	The correction of the ICH DC offset has failed.
-4514	AWG ICH (Variable Amp I) DC offset out of range	The correction of the ICH DC offset has failed.
-4515	AWG QCH (Differential Q) DC offset out of range	The correction of the QCH DC offset has failed.
-4516	AWG QCH (Differential *Q) DC offset out of range	The correction of the QCH DC offset has failed.
-4517	AWG QCH (Single end Q) DC offset out of range	The correction of the QCH DC offset has failed.
-4518	AWG QCH (Fixed Amp Q) DC offset out of range	The correction of the QCH DC offset has failed.
-4519	AWG QCH (Variable Amp Q) DC offset out of range	The correction of the QCH DC offset has failed.
4520	AWG ICH BIAS (0.75V) out of range	The correction of the ICH bias voltage has failed.
-4521	AWG ICH BIAS (0.70V) out of range	The correction of the ICH bias voltage has failed.
-4522	AWG ICH BIAS (0.60V) out of range	The correction of the ICH bias voltage has failed.
-4523	AWG ICH BIAS (0.50V) out of range	The correction of the ICH bias voltage has failed.

## A.3 Error Codes

Error number	Displayed message	Description
-4524	AWG ICH BIAS (0.40V) out of range	The correction of the ICH bias voltage has failed.
-4525	AWG ICH BIAS (0.30V) out of range	The correction of the ICH bias voltage has failed.
-4526	AWG ICH BIAS (0.20V) out of range	The correction of the ICH bias voltage has failed.
-4527	AWG ICH BIAS (0.10V) out of range	The correction of the ICH bias voltage has failed.
-4528	AWG ICH BIAS (-0.10V) out of range	The correction of the ICH bias voltage has failed.
-4529	AWG ICH BIAS (-0.20V) out of range	The correction of the ICH bias voltage has failed.
-4530	AWG ICH BIAS (-0.30V) out of range	The correction of the ICH bias voltage has failed.
-4531	AWG ICH BIAS (-0.40V) out of range	The correction of the ICH bias voltage has failed.
-4532	AWG ICH BIAS (-0.50V) out of range	The correction of the ICH bias voltage has failed.
-4533	AWG ICH BIAS (-0.60V) out of range	The correction of the ICH bias voltage has failed.
-4534	AWG ICH BIAS (-0.70V) out of range	The correction of the ICH bias voltage has failed.
-4535	AWG ICH BIAS (-0.75V) out of range	The correction of the ICH bias voltage has failed.
-4540	AWG QCH BIAS (0.75V) out of range	The correction of the QCH bias voltage has failed.
-4541	AWG QCH BIAS (0.70V) out of range	The correction of the QCH bias voltage has failed.
-4542	AWG QCH BIAS (0.60V) out of range	The correction of the QCH bias voltage has failed.
-4543	AWG QCH BIAS (0.50V) out of range	The correction of the QCH bias voltage has failed.
-4544	AWG QCH BIAS (0.40V) out of range	The correction of the QCH bias voltage has failed.
-4545	AWG QCH BIAS (0.30V) out of range	The correction of the QCH bias voltage has failed.
-4546	AWG QCH BIAS (0.20V) out of range	The correction of the QCH bias voltage has failed.
-4547	AWG QCH BIAS (0.10V) out of range	The correction of the QCH bias voltage has failed.
-4548	AWG QCH BIAS (-0.10V) out of range	The correction of the QCH bias voltage has failed.
-4549	AWG QCH BIAS (-0.20V) out of range	The correction of the QCH bias voltage has failed.
-4550	AWG QCH BIAS (-0.30V) out of range	The correction of the QCH bias voltage has failed.
-4551	AWG QCH BIAS (-0.40V) out of range	The correction of the QCH bias voltage has failed.
-4552	AWG QCH BIAS (-0.50V) out of range	The correction of the QCH bias voltage has failed.
-4553	AWG QCH BIAS (-0.60V) out of range	The correction of the QCH bias voltage has failed.
-4554	AWG QCH BIAS (-0.70V) out of range	The correction of the QCH bias voltage has failed.
-4555	AWG QCH BIAS (-0.75V) out of range	The correction of the QCH bias voltage has failed.
-4560	AWG ICH Level (Through) out of range	The level correction for the ICH filter has failed.
-4561	AWG ICH Level (Wide) out of range	The level correction for the ICH filter has failed.
-4562	AWG ICH Level (Narrow) out of range	The level correction for the ICH filter has failed.
-4565	AWG QCH Level (Through) out of range	The level correction for the QCH filter has failed.
-4566	AWG QCH Level (Wide) out of range	The level correction for the QCH filter has failed.
-4567	AWG QCH Level (Narrow) out of range	The level correction for the QCH filter has failed.
-4570	AWG ICH Level (2.05V) out of range	The correction of the ICH level has failed.

Error number	Displayed message	Description
-4571	AWG ICH Level (2.00V) out of range	The correction of the ICH level has failed.
-4572	AWG ICH Level (1.75V) out of range	The correction of the ICH level has failed.
-4573	AWG ICH Level (1.50V) out of range	The correction of the ICH level has failed.
-4574	AWG ICH Level (1.25V) out of range	The correction of the ICH level has failed.
-4575	AWG ICH Level (1.00V) out of range	The correction of the ICH level has failed.
-4576	AWG ICH Level (0.75V) out of range	The correction of the ICH level has failed.
-4577	AWG ICH Level (0.50V) out of range	The correction of the ICH level has failed.
-4578	AWG ICH Level (0.25V) out of range	The correction of the ICH level has failed.
-4579	AWG ICH Level (0.15V) out of range	The correction of the ICH level has failed.
-4585	AWG QCH Level (2.05V) out of range	The correction of the QCH level has failed.
-4586	AWG QCH Level (2.00V) out of range	The correction of the QCH level has failed.
-4587	AWG QCH Level (1.75V) out of range	The correction of the QCH level has failed.
-4588	AWG QCH Level (1.50V) out of range	The correction of the QCH level has failed.
-4589	AWG QCH Level (1.25V) out of range	The correction of the QCH level has failed.
-4590	AWG QCH Level (1.00V) out of range	The correction of the QCH level has failed.
-4591	AWG QCH Level (0.75V) out of range	The correction of the QCH level has failed.
-4592	AWG QCH Level (0.50V) out of range	The correction of the QCH level has failed.
-4593	AWG QCH Level (0.25V) out of range	The correction of the QCH level has failed.
-4594	AWG QCH Level (0.15V) out of range	The correction of the QCH level has failed.

### A.4 Description of Standard Waveform Generation Software

This section describes the standard waveform generation software.

#### A.4.1 Overview

The standard waveform generation software is used to generate general-purpose modulation signals. Figure A-10 indicates a block diagram of the software.

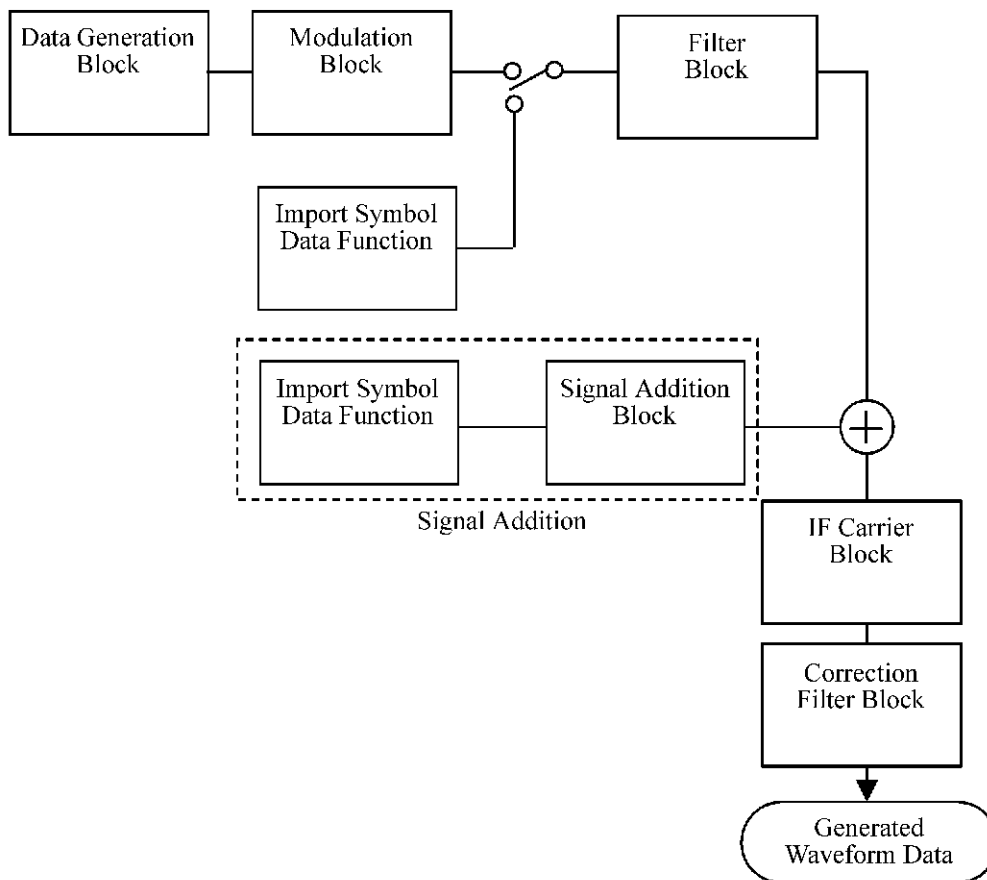

Figure A-10 Signal Generation Block Diagram

- **Data Generation Block**  
The Data Generation Block generates data sequences that are to be modulated. This block is provided with functions to generate PN codes and load data from files.
- **Modulation Block**  
In the Modulation Block, data generated in the Data Generation Block is encoded and mapped.
- **Filter Block**  
This block performs a filtering operation for data from the Modulation Block.  
This block is also provided with a function to load the filter impulse response data file.
- **Signal Addition Block**  
This block is used to generate noise. It is also possible to add noise generated in this block to data from the Filter Block.
- **Import Symbol Data Function**  
A function to load user-generated signal data is provided.
- **IF Carrier Block**  
Carrier-related operations are performed for generated signal data.
- **Correction Filter Block**  
This block is used to correct frequency characteristics specific to the AWG hardware and improve the modulation accuracy.

---

**MEMO:** *Settings for the correction filter block are made form the menu.*

---

A.4.2 Software Activation

**A.4.2 Software Activation**

The menu bar of this option is arranged as follows:

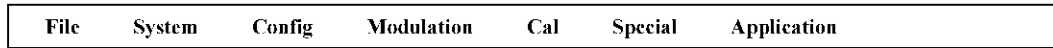

To activate the standard waveform generation software, select **[Wave Generator]** from **[Application]** on the menu bar.

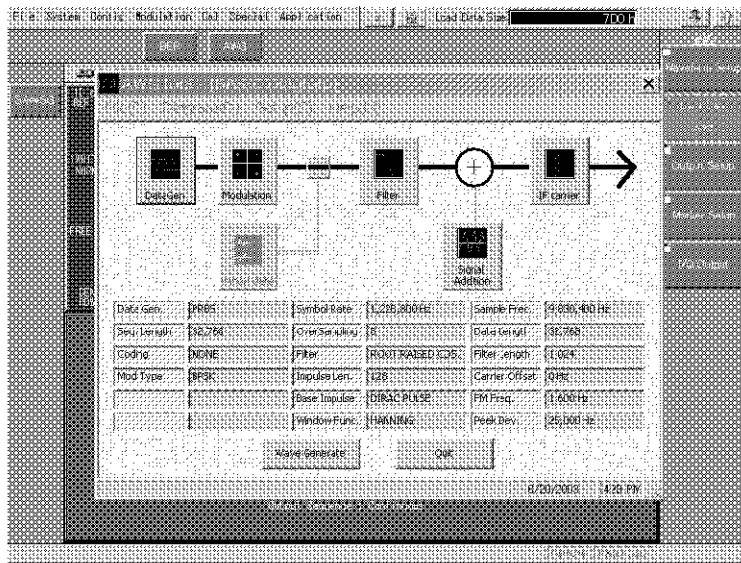

Figure A-11 After the Standard Waveform Generation Software is Activated

---

**MEMO:** The display after starting the software varies depending on the state of last use.

---

### A.4.3 Window and Menus

#### 1. Main window

Figure A-12 shows the main window of the standard waveform generation software.

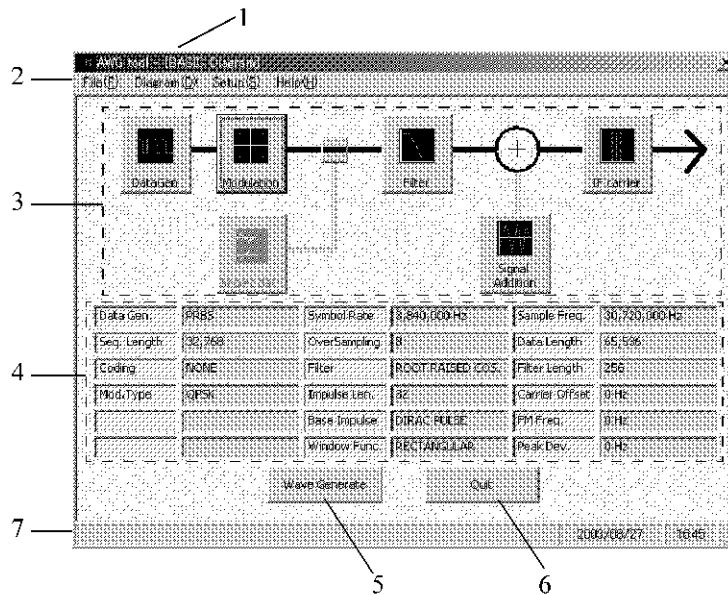

Figure A-12 Main Window

- |   |  |
|---|--|
| 1. Title and diagram                      | The software title is indicated.<br>The selected diagram is indicated.   |
| 2. Menu bar                               | The menus are indicated.   |
| 3. Blocks and signal processing flow      | Each block and connections among those blocks are indicated in a block diagram. Signals are processed in the order that these blocks are connected.            |
| 4. Fields to indicate setting information | Major settings for each block are indicated.   |
| 5. Button to output waveform data         | After operations to make settings for each block are completed, press this button to output waveform data. Waveform data is generated by pressing this button. |
| 6. BASIC Diagram quite button             | Quits the BASIC Diagram.   |
| 7. Status indication field                | If a setting for a block is made outside the setting range, an error message is indicated here.  |

A.4.3 Window and Menus

2. Menus

- File menu

Perform file operations or terminate software operation.

Figure A-13 indicates the file menu items.

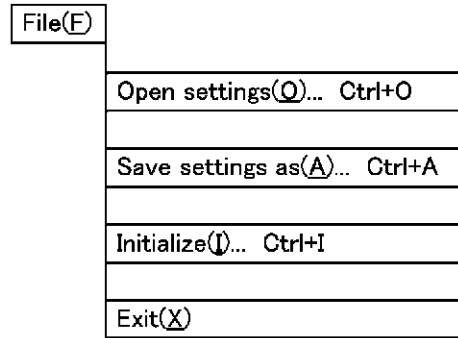

Figure A-13 File Menu

Table A-1 File Menu

Menu item name	Description
Open settings	Settings that have been saved are loaded.
Save settings as	Settings are saved.
Initialize	The settings return to their initial states.
Exit	The software operation is terminated.

- Diagram menu

Select a diagram.

Figure A-14 indicates diagram menu items.

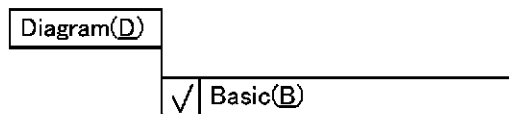

Figure A-14 Diagram Menu

Table A-2 Diagram Menu

Menu item name	Description
Basic	The basic diagram is set for the blocks and signal processing flow.



## 3. Setup menu

Set up the software using this menu.

Figure A-15 indicates the setup menu configuration.

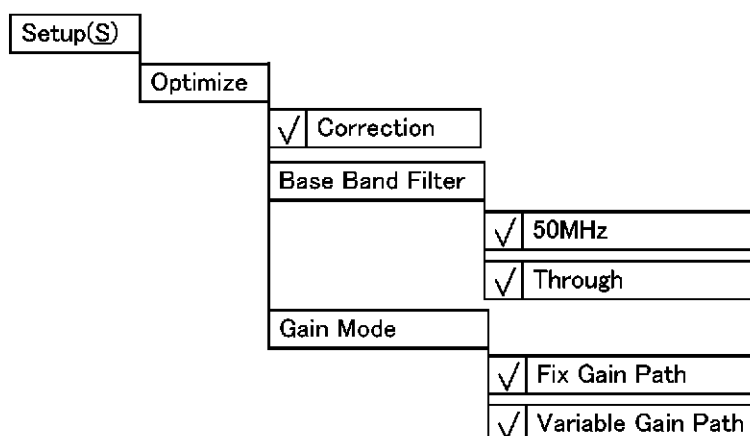

Figure A-15 Setup Menu

Table A-3 Setup Menu

Menu item name	Description
Optimize	A function to correct frequency characteristics of the AWG hardware (amplitude and phase characteristics) using digital signal processing and consequently output the most suitable waveform data is provided.
Correction	Check the "Correction" item to enable the optimization function. If this item is not checked, the optimization function is disabled.
Base Band Filter	Select a base-band filter of the AWG for which an optimization operation is to be performed.
Gain Mode	Select a gain mode of the AWG for which an optimization operation is to be performed.

**IMPORTANT:**

1. *If the settings for optimization (base-band filter and gain mode) are different from those for this instrument, the waveform quality will deteriorate.*
2. *Optimized waveform data files cannot be used in any other R3681 series AWG. Data in the optimized waveform data files is specific to this instrument.*

A.4.3 Window and Menus

4. Help menu

Displays information such as the software version.

Figure A-16 shows the Help menu.

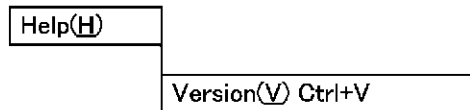

Figure A-16 Help Menu

Table A-4 Help Menu

Menu	Description
Version	Displays information such as the software version.

#### A.4.4 Function of Each Block

##### 1. Data Generation Block

Figure A-17 indicates the dialog box to make settings for the Data Generation Block.

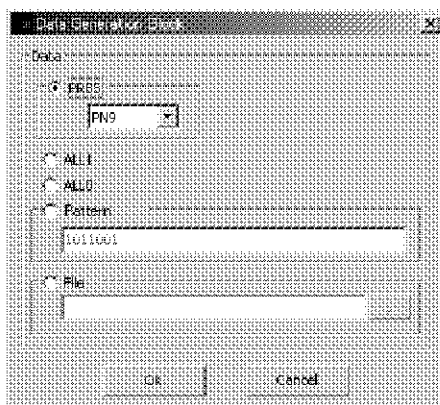

Figure A-17 Dialog Box to Make Settings for the Data Generation Block

- Selectable generated codes  
Select a code that is to be used as the source for modulation. Table A-5 indicates selectable patterns.

Table A-5 Selectable Generated Codes

Selectable generated codes	
PRBS patterns	PN7
	PN9
	PN11
	PN15
	PN19
	PN20
	PN23
ALL1	Pattern with 1 in each bit.
ALL0	Pattern with 0 in each bit.
Pattern	Pattern generated by repeating a user-specified input pattern.
FILE	Pattern loaded from a file.

A.4.4 Function of Each Block

- The following indicate generating polynomials for PRBS

PN7:  $1+X^6+X^7$  (complying with CCITT V.29)

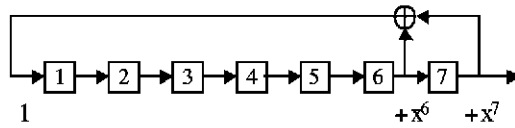

PN9:  $1+X^5+X^9$  (complying with CCITT V.52)

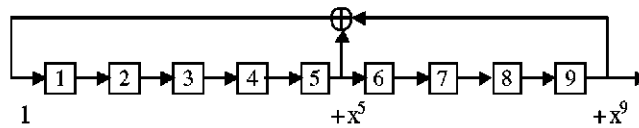

PN11:  $1+X^9+X^{11}$  (complying with CCITT O.152)

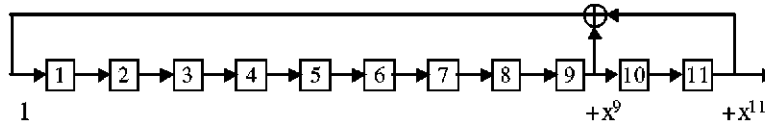

PN15:  $1+X^{14}+X^{15}$  (complying with CCITT O.151) \* The output data is inverted.

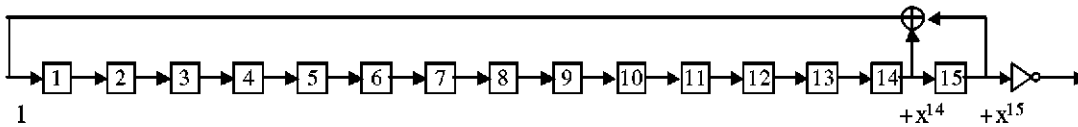

PN19:  $1+X+X^2+X^5+X^{19}$  (complying with CCITT I.430)

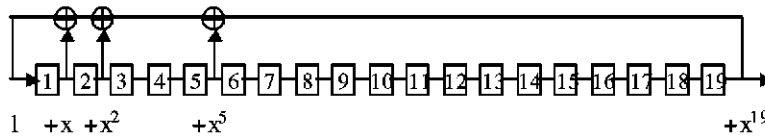

PN20:  $1+X^3+X^{20}$  (complying with CCITT V.57)

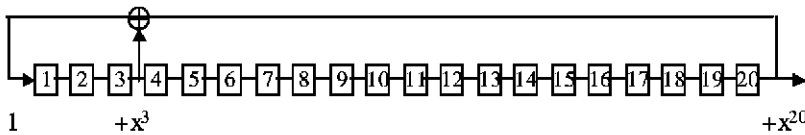

PN23:  $1+X^{18}+X^{23}$  (complying with CCITT O.151) \* The output data is inverted.

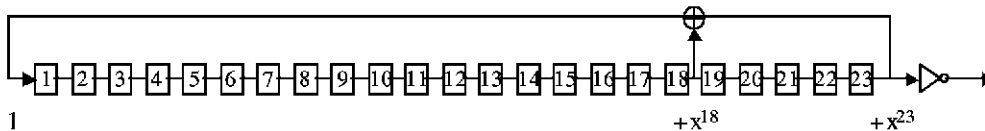

## 2. Modulation Block

Figure A-18 indicates the dialog box to make settings for the Modulation Block.

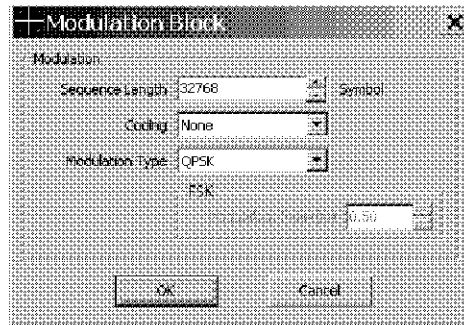

Figure A-18 Dialog Box to Make Settings for the Modulation Block

- Parameters for which settings can be made

Table A-6 indicates parameters for which settings can be made.

Table A-6 Parameters for which Settings can be Made

Function	Setting
Sequence Length	Set the number of symbols.
Coding	None
	Gray Code
	Differential
	Gray Differential
Modulation Type	BPSK
	QPSK
	16QAM
	64QAM
	256QAM
	FSK
Modulation Index	Modulation index (the setting is enabled only for FSK modulation)

A.4.4 Function of Each Block

- Relationships between Sequence Length and the number of generated codes on a Modulation Type basis  
 Table A-7 indicates relationships between the number of codes to be generated in the Data Generation Block and the number of symbols.

Table A-7 Relationships between Sequence Length and the Number of Generated Codes on a Modulation Type Basis

Modulation Type	Number of codes [bits]
BPSK	Sequence Length setting × 1 (The number of bits per symbol) = 1
QPSK	Sequence Length setting × 2 (The number of bits per symbol) = 2
16QAM	Sequence Length setting × 4 (The number of bits per symbol) = 4
64QAM	Sequence Length setting × 6 (The number of bits per symbol) = 6
256QAM	Sequence Length setting × 8 (The number of bits per symbol) = 8
FSK	Sequence Length setting × 1 (The number of bits per symbol) = 1

- Coding
  - None  
Binary codes are mapped as they are.
  - Gray Code  
Binary codes are converted to gray codes, and mapping is made for the gray codes.
  - Differential  
Differential codes are generated using the following equation and then are mapped.  

$$b_k = a_k + b_{k-1} \pmod{M} \quad (k=1,2,3,- - -n)$$

$$M = 4 \text{ for QPSK}$$

$$M = 16 \text{ for 16QAM}$$

$$b_0 = 0$$
  - Gray Differential  
First, gray codes are generated. Differential codes are generated from the gray codes. Then mapping is made for the differential codes.

## 3. Import Symbol Data Function (Load Symbol Data)

Figure A-19 indicates the dialog box to make settings for “Import Symbol Data Function.”



Figure A-19 Dialog Box to Make Settings for “Import Symbol Data Function”

- Parameters for which settings can be made

Table A-8 indicates parameters for which settings can be made.

Table A-8 Parameters for which Settings can be Made

Function	Setting
Sequence Length	Set the number of symbols.
Import Symbol Data	Specify a symbol data file.

- Format of files from which data is to be loaded  
Refer to A.4.5, “Format of Files to Be Loaded in Each Block.”

A.4.4 Function of Each Block

4. Filter Block

Figure A-20 indicates the dialog box to make settings for the Filter Block.

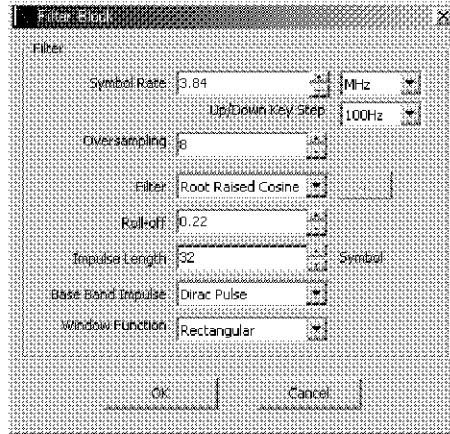

Figure A-20 Dialog Box to Make Settings for Filter Block

- Parameters for which settings can be made  
Table A-9 indicates parameters for which settings can be made.

Table A-9 Parameters for which Settings can be Made

Function	Setting parameter	
Symbol Rate	Set a symbol rate.	
Over Sampling	Sets the over-sampling ratio to the symbol rate.	
Filter	Gauss	BT product: $0.1 \leq BT \leq 10.0$ [0.1step]
	Raised Cosine	Roll-off factor: $0.01 \leq \alpha \leq 0.99$ [0.01step]
	Root Raised Cosine	Roll-off factor: $0.01 \leq \alpha \leq 0.99$ [0.01step]
	User	Impulse Length = 4 to 2561 taps
Roll off or BT	Set a roll-off factor or a BT product.	
Impulse Length	Set a filter length.	
Base Band Impulse	Dirac Pulse	
	Rectangular	
Window Function	Rectangular	
	Hamming	
	Hanning	
	Blackman	



- Base-band pulse
  - Select one from the following two over-sampling methods:
    - Dirac Pulse
      - Insert zeros to perform an over-sampling operation.
    - Rectangular
      - Perform an over-sampling operation by using Zero Order Hold.

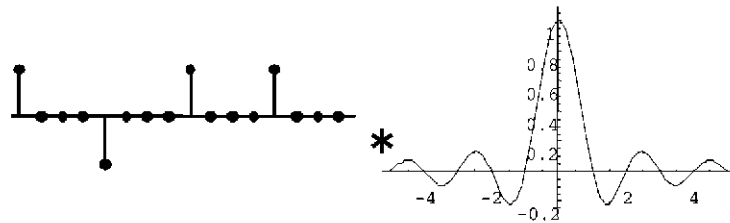

Figure A-21 Dirac Pulse

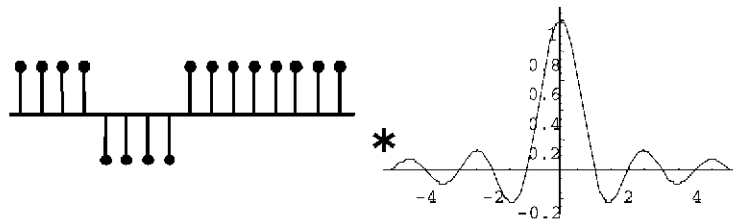

Figure A-22 Rectangular

- Characteristics of each filter are specified by the corresponding equations that follow:
  - Gaussian filter (BT: 0.1 to 10.0)

$$h(t) = \frac{\text{Exp}[-t^2 / (2\sigma^2 T^2)]}{(2\pi)^{1/2} \sigma T}, \quad \sigma = \frac{(\ln 2)^{1/2}}{2\pi BT}$$

- Root raised cosine filter ( $\alpha$ : 0.01 to 0.99)

$$h(t) = \frac{4\alpha \cdot \text{Cos}[(1 + \alpha)\pi t / T] + \text{Sin}[(1 - \alpha)\pi t / T] / (t / T)}{\pi \{1 - (4\alpha t / T)^2\}}$$

At  $t = 0$

$$h(0) = \frac{4\alpha}{\pi} + 1 - \alpha$$

At  $1 - (4\alpha t / T)^2 = 0$

$$h(t) = \beta \left\{ \text{Cos} \left[ \frac{\pi(1 - \alpha)}{4\alpha} \right] + \frac{2}{\pi} \text{Sin} \left[ \frac{\pi(1 - \alpha)}{4\alpha} \right] \right\}$$

A.4.4 Function of Each Block

- Raised cosine filter ( $\alpha$ : 0.01 to 0.99)

$$h(t) = \left[ \frac{\text{Sin}[\pi t/T]}{\pi t/T} \right] \left[ \frac{\text{Cos}[\alpha \pi t/T]}{1 - 4(\alpha t/T)^2} \right]$$

At  $t = 0$

$$h(0) = 1$$

At  $1 - 4(\alpha t/T)^2 = 0$

$$h(t) = \alpha \cdot \frac{\text{Sin}[\pi/(2\alpha)]}{2}$$

- The window functions used for the filters are indicated by the following equations:  $N$  indicates the number of filter taps.
  - Rectangular  
No window processing is conducted for the filters.
  - Hamming  
 $w(i) = 0.54 - 0.46 \cdot \text{Cos}[2\pi i/(N - 1)] \quad , 0 \leq i < N$
  - Hanning  
 $w(i) = 0.5 - 0.5 \cdot \text{Cos}[2\pi i/(N - 1)] \quad , 0 \leq i < N$
  - Blackman  
 $w(i) = 0.42 - 0.5 \cdot \text{Cos}[2\pi i/(N - 1)] + 0.08 \cdot \text{Cos}[2 \cdot 2\pi i/(N - 1)] \quad , 0 \leq i < N$

## 5. Signal Addition Block

Figure A-23 indicates the dialog box to make settings for the Signal Addition Block.

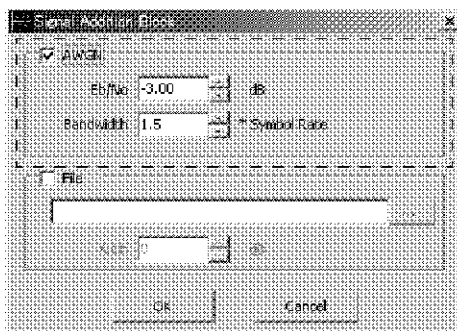

Figure A-23 Dialog Box to Make Settings for Signal Addition Block

- Parameters for which settings can be made

Table A-10 indicates parameters for which settings can be made.

Table A-10 Parameters for which Settings can be Made

Function	Setting parameter	
AWGN ON/OFF	ON	AWGN is generated.
	OFF	AWGN is not generated.
Eb/No	Set an Eb/No ratio. Setting range: -3.00 to 80.00 [dB] 0.01 dB/Step	
Band width	Set the AWGN bandwidth as a multiple of the Symbol Rate bandwidth. Setting range: 1.0 to 2.0, 0.1/Step	

- Eb/No is calculated using the following equation:

$$E_b / N_0 [dB] = \frac{C}{N} \cdot \frac{B_w}{f_b}$$

Here

C: Carrier power, N: Noise power,  $B_w$ : Noise bandwidth [Hz],  $f_b$ : Bit rate

A.4.4 Function of Each Block

6. Signal Addition Block

Figure A-24 indicates the dialog box to make settings for “Signal Addition Block.”

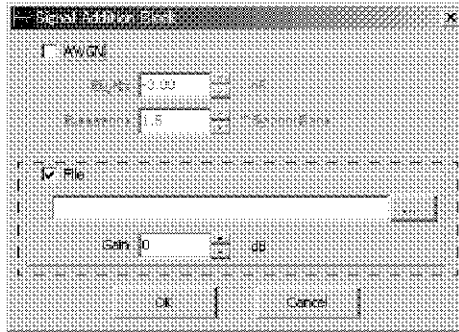

Figure A-24 Dialog Box for Signal Addition Block

- Parameters for which settings can be made  
Table A-11 indicates parameters for which settings can be made.

Table A-11 Parameters for which Settings can be Made

Function	Setting parameter	
FILE ON/OFF	ON	Loaded signal data is added.
	OFF	Loaded signal data is not added.
File name	Specify a signal data file.	
Gain	Enter a relative gain for the signal that is to be added.	

- Format of files from which data is to be loaded  
Refer to A.4.5, “Format of Files to Be Loaded in Each Block.”

## 7. IF Carrier Block

Figure A-25 indicates the dialog box to make settings for the IF Carrier Block.

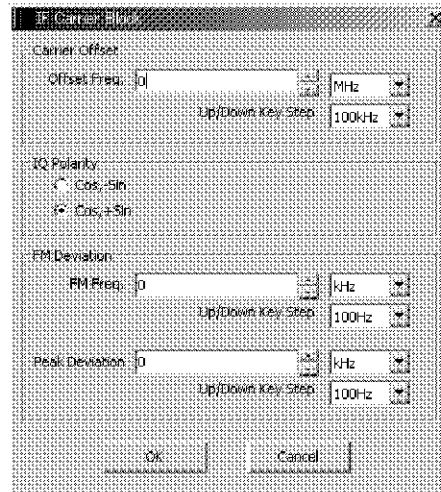

Figure A-25 Dialog Box to Make Settings for the IF Carrier Block

- Parameters for which settings can be made

Table A-12 indicates parameters for which settings can be made.

Table A-12 Parameters for which Settings can be Made

Function	Setting parameter
Carrier offset	Set a carrier frequency offset. Setting range: $f_c \pm OverSampling \times (SymbolRate \div 2) - SymbolRate$
IQ Polarity	{Cos, -Sin}
	{Cos, Sin}
FM Deviation	The carrier frequency is FM-modulated. Setting range: $2(\Delta f + fm) < (NyquistRate - BaseBandWidth)$

A.4.4 Function of Each Block

- IQ polarity

The following operation is performed according to the IQ polarity setting:

{Cos, -Sin}

$$(I + jQ)(\cos(\omega_c t) - j \sin(\omega_c t))$$

{Cos, Sin}

$$(I + jQ)(\cos(\omega_c t) + j \sin(\omega_c t))$$

$$j = \sqrt{-1}$$

- FM modulation is indicated in the following equation:

$$s(t) = \text{Cos} \left[ 2\pi f_c t + \frac{\Delta f}{f_m} \text{Sin}[2\pi f_m t] \right] \pm j \text{Sin} \left[ 2\pi f_c t + \frac{\Delta f}{f_m} \text{Sin}[2\pi f_m t] \right]$$

### A.4.5 Format of Files to Be Loaded in Each Block

This section describes the formats of the files from which data is to be loaded in each block.

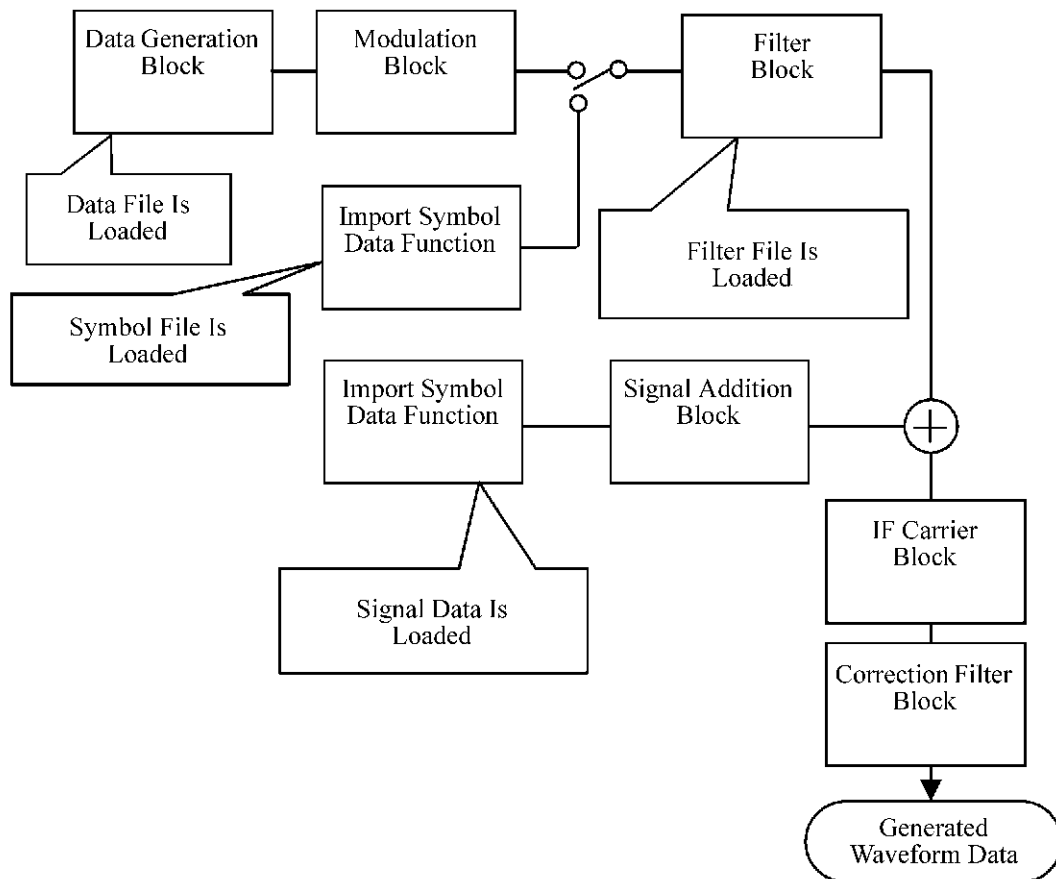

A.4.5 Format of Files to Be Loaded in Each Block

1. Data Generation Block

In the Data Generation Block, user-generated data files can be loaded.

- File extension  
Use “\*.ptn” as the extension of these data files.
- File structure  
Use ASCII for data in the files and enter a column, each component of which is 0 or 1 data.

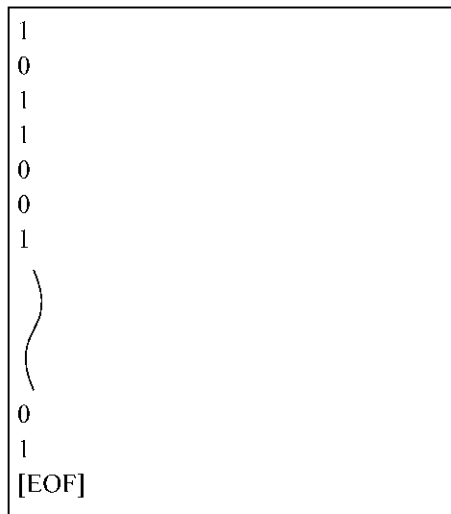

---

**IMPORTANT:** *If the number of data described is larger than that set for the symbols generated, only the data up to the number of symbols is used, and the remaining data is discarded. If the number of data described is smaller than that set for the symbols generated, the data in the file is used repeatedly starting at the initial data.*

---



## 2. Import Symbol Data Function (Symbol Data)

With the "Import Symbol Data" function, user-generated symbol data can be loaded.

- File extension  
Use "\*.sbl" as the extension of the symbol files.
- File structure  
Use the CSV format for data in these files and enter I data in the first column followed by Q data in the second column.

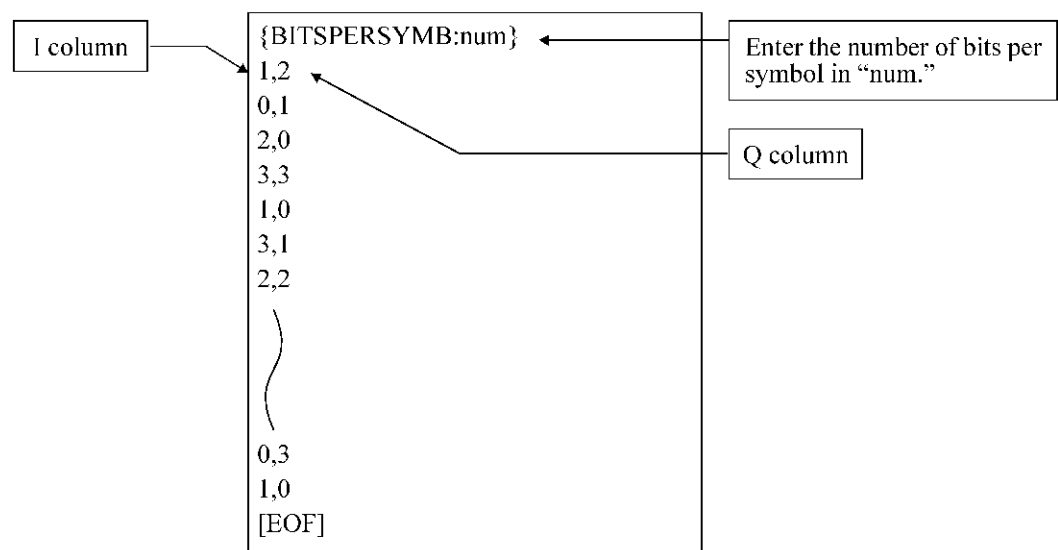

A.4.5 Format of Files to Be Loaded in Each Block

3. Filter Block

In the Filter Block, filter coefficients can be loaded.

- File extension  
Use “.flt” as the extension of the filter files.
- File structure  
Use ASCII for data in these files and enter filter coefficients in a column.

```
-2.5288314999961183e-002  
-2.7655819316888042e-002  
-2.9979637948471118e-002  
-3.2188896808327136e-002  
-3.4167931000007271e-002  
  
~  
  
-3.5794963591670420e-002  
-3.6779845576961380e-002  
-3.6852181608548716e-002  
[EOF]
```

---

**IMPORTANT:** *If the number of data described in the filter file is larger than that set for the filter, only necessary filter coefficients are used, and the remaining data is discarded. If the number of data is insufficient, zero (0) is used for the coefficients that are not provided.*

---

## 4. Import Symbol Data Function (waveform data)

User-generated signal data can be loaded.

- File extension

Use “\*.fwv” as the extension of the signal data files.

- File structure

Use the CSV format for data in the files and enter the I signal data in the first column followed by the Q signal data in the second column.

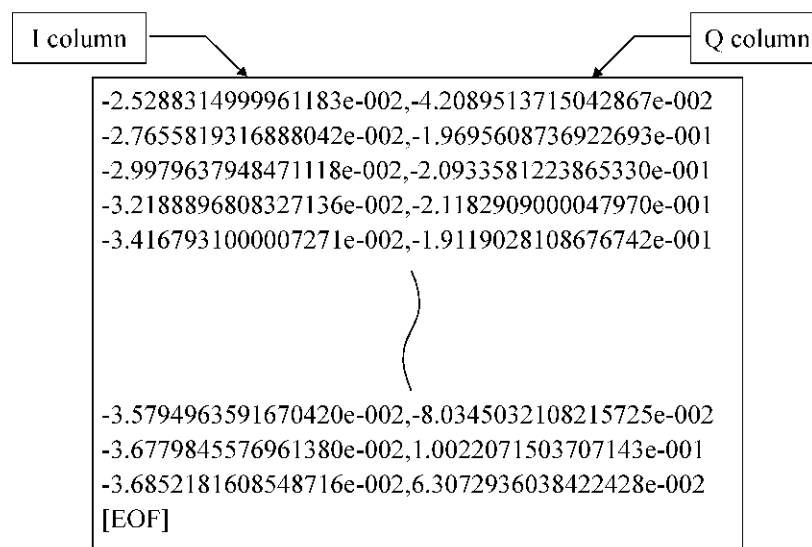

**A.4.6 Error Codes for Standard Waveform Generation Software**

Error code	Error message	Description	Sub message No.
0	Successfully Completed.	Completed correctly.	
1001	Bit length is outside the range.	The bit length is outside the range.	
1003	Sequence length is outside the range.	The sequence length (the number of symbols) is outside the range.	
1004	The value given by sequence length $\times$ OSR is outside the range.	The value given by the sequence length $\times$ OSR is outside the range.	5
1005	TAP (filter length) is outside the range.	TAP (filter length) is outside the range.	2
1006	Oversampling ratio is outside the range.	The over-sampling ratio is outside the range.	
1008	Modulation index is outside the range.	The modulation index is outside the range.	
1009	The rate of Roll-off (rate of BT) is outside the range.	The Roll-off rate (rate of BT) is outside the range.	
1012	Eb/No ratio is outside the range.	The Eb/No ratio is outside the range.	
1013	The magnification of noise restriction band width is outside the range.	The magnification of the noise restriction band-width is outside the range.	
1017	Modulation frequency is outside the range.	The modulation frequency is outside the range.	
1019	Symbol rate is outside the range.	The symbol rate is outside the range.	
1020	Carrier frequency is outside the range.	The carrier frequency is outside the range.	3
1021	Deviation is outside the range.	The deviation is outside the range.	
1022	Modulation frequency or Deviation is outside the range.	The modulation frequency or the deviation is outside the range.	4
1023	Gain is outside the range.	The gain is outside the range.	
1150	This file has already existed.	The file already exists.	
1151	Fail to write the file.	Cannot write the file.	
1152	Fail to read the pattern file.	Cannot read the pattern file.	6, 7, 8
1153	Fail to read the symbol file.	Cannot read the symbol file.	6, 7, 8
1154	Fail to read the impulse response file.	Cannot read the impulse response file.	6, 7, 8
1155	Fail to read the noise filter setup file.	Cannot read the noise filter setup file.	6
1156	Fail to read the signal file.	Cannot read the signal file.	6, 7
1158	It is not the file saved by this program.	This file was not saved by this program.	9
1159	It is not the file saved by BASIC Diagram.	This file was not saved by BASIC Diagram.	9

Error code	Error message	Description	Sub message No.
-	Are you sure to initialize setup parameters?	Initialize setup parameters?	
-	Generating waveform data now, please wait...	Generating waveform data. Please wait...	
-	Waveform data generation was canceled.	Waveform data generation was canceled.	

Submessage No.	Sub message
2	$(2561 < \text{ImpulseLength} * \text{OSR})$
3	$(\text{SymRate} * \text{OSR} / 2 - \text{SymRate} <  \text{Carrier Freq.} )$
4	$(\text{SymRate} * \text{OSR} / 2 - \text{SymRate} < 2(\text{Mod. Freq} + \text{Dev.}))$
5	$(2,097,152\text{Bit} < \text{SequenceLength} * \text{OSR})$
6	Please check the place of a file.
7	Please check whether the data in a file is right.
8	File Name = <file name>
9	Reading of a file was stopped.



## ALPHABETICAL INDEX

<b>[Symbol]</b>	
[16M Word × 4] .....	5-9
[32M Word × 2] .....	5-9
[64M Word × 1] .....	5-9
[Apply] .....	5-9, 5-17, 5-18
[Auto] .....	5-4
[Auto Load] .....	5-9, 5-11
[AWG Memory Mapping Information] ..	5-9, 5-10
[CH Start Freq] .....	5-25
[CH Start No.] .....	5-25
[CH Step Freq] .....	5-25
[Clock Gate] .....	5-4, 5-6
[Clock Slope] .....	5-4, 5-6
[Continuous] .....	5-9, 5-14
[Data Polarity] .....	5-4, 5-5
[External] .....	5-4
[External Trigger Slope] .....	5-4, 5-7
[Falling] .....	5-4
[Fix Gain Path(1 V <sub>p-p</sub> )] .....	5-10, 5-18
[Gated] .....	5-9, 5-15
[High] .....	5-4
[High Period] .....	5-17
[High Period 1] .....	5-9
[I] .....	5-18, 5-19
[I 0 mV] .....	5-10
[I 1000 mV <sub>p-p</sub> ] .....	5-10
[I/Q Gain] .....	5-20
[I/Q Offset] .....	5-10, 5-19, 5-20
[I/Q Output] .....	5-10, 5-18
[I/Q Output Filter] .....	5-10, 5-19
[I/Q Phase] .....	5-20
[I/Q value Interlock] .....	5-10, 5-18, 5-19
[Internal] .....	5-4, 5-9
[Link] .....	5-9
[Load Data Size] .....	5-9, 5-12
[Load File] .....	5-9, 5-12
[Load Waveform] .....	5-9, 5-10
[Loop Num] .....	5-14
[Loop Num 1] .....	5-9
[Loop Number] .....	5-17
[Loop Number 1] .....	5-9
[Low] .....	5-4
[Low Period] .....	5-17
[Low Period 1] .....	5-9
[Map Number] .....	5-9, 5-11
[Marker] .....	5-9, 5-13
[Marker 1(to SA)] .....	5-9, 5-16
[Marker 2(to Rear)] .....	5-9, 5-17
[Marker1] .....	5-9, 5-14
[Marker2] .....	5-9, 5-14
[Memory] .....	5-9, 5-16
[Memory Segments] .....	5-9, 5-10
[Mode] .....	5-9, 5-16
[Neg] .....	5-9
[Negative] .....	5-4, 5-9, 5-14
[OFF] .....	5-9, 5-10, 5-18
[Off] .....	5-4
[ON] .....	5-9
[Output Sequence] .....	5-9, 5-14
[Output Waveform Select] .....	5-9, 5-13
[Polarity] .....	5-9, 5-17
[Pos] .....	5-9
[Positive] .....	5-4, 5-9, 5-14
[PRBS] .....	5-4, 5-5
[Q] .....	5-18, 5-19
[Q 0 mV] .....	5-10
[Q 1000 mV <sub>p-p</sub> ] .....	5-10
[Rising] .....	5-4
[Sampling Freq] .....	5-13
[Sampling Freq 200.0000000000 MHz]	5-9
[Select Wave] .....	5-9, 5-16
[Sequencer] .....	5-9, 5-16
[Sequencer Setup] .....	5-9, 5-16
[Single] .....	5-9, 5-14
[Start Offset Period] .....	5-17
[Start Offset Period 0] .....	5-9
[Start Trigger] .....	5-4, 5-7, 5-9, 5-14
[Sync Mode] .....	5-4, 5-7
[Total Length] .....	5-9, 5-16
[Trigger] .....	5-4
[Trigger Edge] .....	5-9, 5-15
[Trigger Level] .....	5-9, 5-15
[Variable Gain Path] .....	5-10, 5-18
{AMPL} .....	5-22
{AWG} .....	5-9
{BER} .....	5-4
{FREQ} .....	5-25
{MOD} .....	5-20
	<b>[Numerics]</b>
0 dB .....	5-20
3 dB .....	5-20
6 dB .....	5-20

Alphabetical Index

<b>[A]</b>		CW ..... 5-22, 5-24
About Replacement of Limited-Life Parts .. 2-3		Cycle Count ..... 5-4, 5-5
ACLR ..... 8-80, 8-91		
ALC Detector ..... 5-22, 5-24		<b>[D]</b>
ALC Hold Adj ..... 5-22, 5-24		dBm ..... 5-22, 5-23
ALC Hold ADJ Accuracy ..... 8-60, 8-88		dB $\mu$ V ..... 5-22, 5-23
ALC Mode ..... 5-22, 5-24		dB $\mu$ Vemf ..... 5-22, 5-23
ALC On/Off ..... 5-22, 5-24		DC Offset ..... 8-16, 8-48
AMPL ..... 5-3		Description of Standard Waveform
AMPL Button ..... 6-9		Generation Software ..... A-20
Ampl Offset On/Off ..... 5-22, 5-23		Description of the Function of Each Key .. 5-4
Ampl Rel On/Off ..... 5-22, 5-23		Description of the Panels and the Screen .. 4-1
Ampl Step Size ..... 5-22, 5-23		
Ampl Units ..... 5-22, 5-23		<b>[E]</b>
Ampl Upper Limit ..... 5-22, 5-23		Electromagnetic Interference ..... 2-3
Amplitude ..... 5-22, 5-23		Error Codes ..... A-16
APPENDIX ..... A-1		Error Codes for Standard Waveform
Application ..... 5-3		Generation Software ..... A-44
ATT Hold On/Off ..... 5-22, 5-23		Example of Remote Control Program .... 6-15
Attenuator Hold Level Variable Range .. 8-58, 8-88		EXAMPLES OF OPERATIONS ..... 4-1
Auto ..... 5-20, 5-22, 5-24		External IQ Input ..... 8-83, 8-91
Auto Trimming ..... 5-20, 5-21		External Start Trigger ..... 8-29, 8-50
AWG ..... 5-3		
AWG Button ..... 6-6, 6-8		<b>[F]</b>
AWG Performance Verification Procedure .. 8-7		File ..... 5-3
AWG Performance Verification Record		Format of Files to Be Loaded
Sheets ..... 8-47		in Each Block ..... A-39
AWG Specifications ..... 7-1		FREQ ..... 5-3
		FREQ Button ..... 6-10
<b>[B]</b>		Freq Offset On/Off ..... 5-25
Basic Operation ..... 4-7		Freq Rel On/Off ..... 5-25
BER ..... 5-3		Freq Step Size ..... 5-25
BER Button ..... 6-4		Frequency ..... 5-25
BER Display %/Exp ..... 5-4, 5-8		Frequency Accuracy ..... 8-52, 8-87
BER Measurement ..... 6-15		Function Bar ..... 5-3
Bit Error Rate Counter ..... 8-44, 8-51		Function of Each Block ..... A-27
Broadband Noise ..... 8-65, 8-89		FUNCTIONAL EXPLANATION ..... 5-1
		Functions Dedicated to Remote Control . 6-12
<b>[C]</b>		
Cal ..... 5-3		<b>[G]</b>
Channel ..... 5-25		Getting the Software Running
Channel Setup ..... 5-25		with Stability ..... 2-2
Check the supply power ..... 3-6		
Command Reference Format ..... 6-1		<b>[H]</b>
Common Commands ..... 6-3		Handling the Touch Screen ..... 2-2
Config ..... 5-3		Hard Disk Drive ..... 2-1
Connecting Accessories ..... 3-5		Harmonics ..... 8-68, 8-89
Connecting the Keyboard and Mouse ..... 3-5		Header ..... A-2
Connecting the Power Cable ..... 3-6		Header Syntax ..... A-3
Conventions of Notation Used		Hold ..... 5-22, 5-24
in This Document ..... 1-3		



<b>[I]</b>		Output Amplitude .....	8-10, 8-47
I/Q ATT .....	5-20	Output Setup .....	5-9, 5-13
I/Q Input Source Int/Ext .....	5-20	Overcurrent Protection .....	2-1
I/Q Output .....	5-9, 5-18	Overview .....	8-1, A-20
I/Q Trimming .....	5-20	<b>[P]</b>	
If Faults Should Occur .....	2-1	Pass/Fail On/Off .....	5-4, 5-8
Internal Filter .....	8-26, 8-49	PERFORMANCE VERIFICATION .....	8-1
INTRODUCTION .....	1-1	Phase Difference between Channels .....	8-21, 8-49
Introduction .....	8-1	PRE-OPERATION TIPS .....	2-1
<b>[L]</b>		Prevention of Electrostatic Buildup .....	3-3
Level Accuracy .....	8-55, 8-87	Principle of Operation .....	A-12
Limitations Imposed when Using Windows XP .....	2-4	Product Overview .....	1-2
Load Data Size .....	5-9, 5-12	<b>[R]</b>	
Loading Waveform Data .....	8-5	Registered Trademarks .....	1-4
Locating This Instrument .....	3-2	Removing of Case .....	2-1
<b>[M]</b>		Required Instruments .....	8-3
Marker 1 Output .....	8-37, 8-50	Residual DC Offset .....	8-13, 8-48
Marker 2 Output .....	8-40, 8-50	<b>[S]</b>	
Marker Setup .....	5-9, 5-15	Sampling Frequency .....	8-18, 8-49
Measure Bit Length .....	5-4	SCPI COMMAND REFERENCE .....	6-1
Measure Setup .....	5-4, 5-5	SETUP .....	3-1
Menu Bar Related Functions .....	6-11	SFDR .....	8-23, 8-49
Menu Index .....	5-1	SG Performance Verification Procedure .....	8-52
MENU MAP .....	5-1	SG Performance Verification Record .....	
Method to Create a Waveform File .....	A-1	Sheets .....	8-87
MOD .....	5-3	SG Specifications .....	7-3
Modulation .....	5-3, 5-22, 5-24	Signal Output .....	8-7, 8-47
Modulation Accuracy .....	8-74, 8-90	Soft Menu Bar .....	5-3
<b>[N]</b>		Software Activation .....	A-22
Name and Function of Each Part of the Screen .....	4-5	Special .....	5-3
Non-harmonics .....	8-71, 8-90	SPECIFICATIONS .....	7-1
Normal .....	5-22, 5-24	SSB Phase Noise .....	8-62, 8-88
<b>[O]</b>		Status Register .....	6-13
Operating Environment .....	3-2	Stop on Error On/Off .....	5-4
Operating Method .....	4-7	Supply Description .....	3-6
Operation Check .....	3-8	Switching SG+AWG .....	5-3
Operation from Waveform File Loading to I/Q Signal Output .....	4-7	System .....	5-3
Operation of BER Measurement .....	4-17	<b>[T]</b>	
Operation of RF Signal Output .....	4-23	The Name and Functions of Each Component on the Front Panel .....	4-1
Organization of This Document .....	1-1	The Name and Functions of Each Component on the Rear Panel .....	4-6
Origin Offset .....	8-77, 8-91	Tip on Transportation .....	2-3
Other Manuals Pertaining to This Instrument .....	1-2	Tool Menu .....	5-27
		Tool Menu Related Functions .....	6-12
		Trademarks .....	1-4

Alphabetical Index

**[U]**

Unpacking Inspection ..... 3-1

**[W]**

Waveform Data Generation  
(Waveform Data Part) ..... A-7  
Waveform File Configuration ..... A-1  
Waveform Setup ..... 5-9, 5-10  
Window and Menus ..... A-23

## **IMPORTANT INFORMATION FOR ADVANTEST SOFTWARE**

PLEASE READ CAREFULLY: This is an important notice for the software defined herein. Computer programs including any additions, modifications and updates thereof, operation manuals, and related materials provided by Advantest (hereafter referred to as "SOFTWARE"), included in or used with hardware produced by Advantest (hereafter referred to as "PRODUCTS").

### **SOFTWARE License**

All rights in and to the SOFTWARE (including, but not limited to, copyright) shall be and remain vested in Advantest. Advantest hereby grants you a license to use the SOFTWARE only on or with Advantest PRODUCTS.

### **Restrictions**

- (1) You may not use the SOFTWARE for any purpose other than for the use of the PRODUCTS.
- (2) You may not copy, modify, or change, all or any part of, the SOFTWARE without permission from Advantest.
- (3) You may not reverse engineer, de-compile, or disassemble, all or any part of, the SOFTWARE.

### **Liability**

Advantest shall have no liability (1) for any PRODUCT failures, which may arise out of any misuse (misuse is deemed to be use of the SOFTWARE for purposes other than its intended use) of the SOFTWARE. (2) For any dispute between you and any third party for any reason whatsoever including, but not limited to, infringement of intellectual property rights.

## LIMITED WARRANTY

1. Unless otherwise specifically agreed by Seller and Purchaser in writing, Advantest will warrant to the Purchaser that during the Warranty Period this Product (other than consumables included in the Product) will be free from defects in material and workmanship and shall conform to the specifications set forth in this Operation Manual.
2. The warranty period for the Product (the "Warranty Period") will be a period of one year commencing on the delivery date of the Product.
3. If the Product is found to be defective during the Warranty Period, Advantest will, at its option and in its sole and absolute discretion, either (a) repair the defective Product or part or component thereof or (b) replace the defective Product or part or component thereof, in either case at Advantest's sole cost and expense.
4. This limited warranty will not apply to defects or damage to the Product or any part or component thereof resulting from any of the following:
  - (a) any modifications, maintenance or repairs other than modifications, maintenance or repairs (i) performed by Advantest or (ii) specifically recommended or authorized by Advantest and performed in accordance with Advantest's instructions;
  - (b) any improper or inadequate handling, carriage or storage of the Product by the Purchaser or any third party (other than Advantest or its agents);
  - (c) use of the Product under operating conditions or environments different than those specified in the Operation Manual or recommended by Advantest, including, without limitation, (i) instances where the Product has been subjected to physical stress or electrical voltage exceeding the permissible range and (ii) instances where the corrosion of electrical circuits or other deterioration was accelerated by exposure to corrosive gases or dusty environments;
  - (d) use of the Product in connection with software, interfaces, products or parts other than software, interfaces, products or parts supplied or recommended by Advantest;
  - (e) incorporation in the Product of any parts or components (i) provided by Purchaser or (ii) provided by a third party at the request or direction of Purchaser or due to specifications or designs supplied by Purchaser (including, without limitation, any degradation in performance of such parts or components);
  - (f) Advantest's incorporation or use of any specifications or designs supplied by Purchaser;
  - (g) the occurrence of an event of force majeure, including, without limitation, fire, explosion, geological change, storm, flood, earthquake, tidal wave, lightning or act of war; or
  - (h) any negligent act or omission of the Purchaser or any third party other than Advantest.
5. **EXCEPT TO THE EXTENT EXPRESSLY PROVIDED HEREIN, ADVANTEST HEREBY EXPRESSLY DISCLAIMS, AND THE PURCHASER HEREBY WAIVES, ALL WARRANTIES, WHETHER EXPRESS OR IMPLIED, STATUTORY OR OTHERWISE, INCLUDING, WITHOUT LIMITATION, (A) ANY WARRANTY OF MERCHANTABILITY OR FITNESS FOR A PARTICULAR PURPOSE AND (B) ANY WARRANTY OR REPRESENTATION AS TO THE VALIDITY, SCOPE, EFFECTIVENESS OR USEFULNESS OF ANY TECHNOLOGY OR ANY INVENTION.**
6. **THE REMEDY SET FORTH HEREIN SHALL BE THE SOLE AND EXCLUSIVE REMEDY OF THE PURCHASER FOR BREACH OF WARRANTY WITH RESPECT TO THE PRODUCT.**
7. **ADVANTEST WILL NOT HAVE ANY LIABILITY TO THE PURCHASER FOR ANY INDIRECT, INCIDENTAL, SPECIAL, CONSEQUENTIAL OR PUNITIVE DAMAGES, INCLUDING, WITHOUT LIMITATION, LOSS OF ANTICIPATED PROFITS OR REVENUES, IN ANY AND ALL CIRCUMSTANCES, EVEN IF ADVANTEST HAS BEEN ADVISED OF THE POSSIBILITY OF SUCH DAMAGES AND WHETHER ARISING OUT OF BREACH OF CONTRACT, WARRANTY, TORT (INCLUDING, WITHOUT LIMITATION, NEGLIGENCE), STRICT LIABILITY, INDEMNITY, CONTRIBUTION OR OTHERWISE. TORT (INCLUDING, WITHOUT LIMITATION, NEGLIGENCE), STRICT LIABILITY, INDEMNITY, CONTRIBUTION OR OTHERWISE.**
8. **OTHER THAN THE REMEDY FOR THE BREACH OF WARRANTY SET FORTH HEREIN, ADVANTEST SHALL NOT BE LIABLE FOR, AND HEREBY DISCLAIMS TO THE FULLEST EXTENT PERMITTED BY LAW ANY LIABILITY FOR, DAMAGES FOR PRODUCT FAILURE OR DEFECT, WHETHER ARISING OUT OF BREACH OF CONTRACT, TORT (INCLUDING, WITHOUT LIMITATION, NEGLIGENCE), STRICT LIABILITY, INDEMNITY, CONTRIBUTION OR OTHERWISE.**

## **CUSTOMER SERVICE DESCRIPTION**

In order to maintain safe and trouble-free operation of the Product and to prevent the incurrence of unnecessary costs and expenses, Advantest recommends a regular preventive maintenance program under its maintenance agreement.

Advantest's maintenance agreement provides the Purchaser on-site and off-site maintenance, parts, maintenance machinery, regular inspections, and telephone support and will last a maximum of ten years from the date the delivery of the Product. For specific details of the services provided under the maintenance agreement, please contact the nearest Advantest office listed at the end of this Operation Manual or Advantest's sales representatives.

Some of the components and parts of this Product have a limited operating life (such as, electrical and mechanical parts, fan motors, unit power supply, etc.). Accordingly, these components and parts will have to be replaced on a periodic basis. If the operating life of a component or part has expired and such component or part has not been replaced, there is a possibility that the Product will not perform properly. Additionally, if the operating life of a component or part has expired and continued use of such component or part damages the Product, the Product may not be repairable. Please contact the nearest Advantest office listed at the end of this Operation Manual or Advantest's sales representatives to determine the operating life of a specific component or part, as the operating life may vary depending on various factors such as operating condition and usage environment.

## SALES & SUPPORT OFFICES

Advantest Korea Co., Ltd.

22BF, Kyobo KangNam Tower,  
1303-22, Seocho-Dong, Seocho-Ku, Seoul #137-070, Korea  
Phone: +82-2-532-7071  
Fax: +82-2-532-7132

Advantest (Suzhou) Co., Ltd.

Shanghai Branch Office:  
Bldg. 6D, NO.1188 Gumei Road, Shanghai, China 201102 P.R.C.  
Phone: +86-21-6485-2725  
Fax: +86-21-6485-2726

Shanghai Branch Office:  
406/F, Ying Building, Quantum Plaza, No. 23 Zhi Chun Road,  
Hai Dian District, Beijing,  
China 100083  
Phone: +86-10-8235-3377  
Fax: +86-10-8235-6717

Advantest (Singapore) Pte. Ltd.

438A Alexandra Road, #08-03/06  
Alexandra Technopark Singapore 119967  
Phone: +65-6274-3100  
Fax: +65-6274-4055

Advantest America, Inc.

3201 Scott Boulevard, Suite, Santa Clara, CA 95054, U.S.A  
Phone: +1-408-988-7700  
Fax: +1-408-987-0691

ROHDE & SCHWARZ Europe GmbH

Mühldorfstraße 15 D-81671 München, Germany  
(P.O.B. 80 14 60 D-81614 München, Germany)  
Phone: +49-89-4129-13711  
Fax: +49-89-4129-13723

**ADVANTEST**<sup>®</sup>

<http://www.advantest.co.jp>